

An adventure for use with
STAR TREK[®]
THE ROLE PLAYING GAME

MARGIN OF PROFIT



GIBERSON

MARGIN OF PROFIT

An adventure for use with *Star Trek: The Role Playing Game*

Design And Writing: J. Andrew Keith

Editing: Wm. John Wheeler

Production:

Graphics And Layout

Dana Knutson
Norman Millier
Jordan Weisman

Illustration: Norman Miller

Typesetting: Karen Vander Mey

Proofreading: Donna Ippolito

Playtesting:

Tom Kokkelenberg
Wayne Budwick
Michael Scott Messenger
Jim Just
Dave Hoffman
Mike Lichter
Debbie Fulton
Dave Fulton

STAR TREK is a trademark of Paramount Pictures Corporation.

STAR TREK II: The Wrath of Khan products are published by FASA Corporation under exclusive license from Paramount Pictures Corporation, the trademark owner.

STAR TREK: The Role Playing Game is published by FASA Corporation under exclusive license from Paramount Pictures Corporation, the trademark owner.

Copyright © 1984 Paramount Pictures Corporation
All Rights Reserved
Printed in the United States of America

No part of this book or the contents of the basic game may be reproduced in any form, or by any means without permission in writing from the publisher.

Published by FASA Corporation
P.O. Box 6930
Chicago, Illinois
60680-6930

Table Of Contents

INTRODUCTION	3
Plot Synopsis	3
Contents Of This Book	3
THE ADVENTURE	4
Setting The Stage	4
A Proposal Of Interest	4
Flight To Coridan	5
At Coridan Starport	5
Sampling The Night Life	5
First Sign Of Trouble	5
The Newscast	6
Conducting An Investigation	6
Starport Administration	6
Richard Jurgens	7
Star Fleet	7
The <i>Roulashakballih</i>	8
The <i>Gavikugh</i>	8
Descale Resources	8
Tarsine Minerals	8
The Streets Of Coridan City	8
Circumstantial Evidence	9
A Solid Lead	9
The Assassination	9
Word From Jergens	10
Loading The Critical Shipment	11
Hijackers	11
Encounter In Space	12
Alternatives	12
Ending The Adventure	13
BACKGROUND INFORMATION	14
Coridan	15
Corporation Files	16
VESSELS	17
The <i>Two Brothers</i>	17
Bunkroom	17
Cargo Bay	17
Bridge	17
The <i>Roulashakballih</i>	19
The <i>Gavikugh</i>	20
CAST OF CHARACTERS	29
GAMEMASTER'S NOTES	46
Hints On Play	46
Character Descriptions	46
Piloting the <i>Two Brothers</i>	46
Alemir Akalzed	46
Judging The Investigation	46
Solving The Puzzle	46
Combat With The <i>Gavikugh</i>	46
Adventure Outcomes	47
Campaign Starting Point	47
Adapting To Ongoing Campaigns	48
Using Other Merchant Player Characters	48
Using A Different Starship	48
Using Orion Player Characters	48
Using Star Fleet Characters	48

Introduction

This adventure for **STAR TREK: The Role Playing Game** is designed for use in conjunction with the supplement **Trader Captains And Merchant Princes**. It is intended for a group of up to nine player-characters involved in mercantile activities; as such, it stresses interaction with other characters as much as, if not more than, confrontation and combat.

PLOT SYNOPSIS

The player characters are a band of typical traders who have recently acquired a small starship fitted to carry cargo. They are approached by a representative of TriMark Industries, a company specializing in the manufacture of power plants and other sophisticated heavy equipment. TriMark offers them a long-term charter, which offers some intriguing chances for profit. The adventurers' charter from TriMark contracts them to carry small cargos from the planet Coridan to the Vega star system. Because of low cash reserves, TriMark will pay the traders in TriMark stock rather than cash, and hence the group has a strong vested interest in seeing the company prosper.

Recently placed under a Federation Protectorate, Coridan is a small world rich in dilithium crystals but poor in manpower. Until recently, it was raided frequently by smugglers who illegally mined and sold the dilithium. Now, with the Protectorate's efforts to encourage local mining companies, off-world firms not only are purchasing and shipping Coridian dilithium, but also have been advising and selling to budding Coridian industries. TriMark has been working to expand the mining industry of Coridan. It is not alone; a number of independent traders and larger corporations are also participating in this small boom of Coridian trade.

When the adventurers reach the planet, they learn that a rash of hijackings have occurred. Cargos of dilithium crystals have been stolen while in transit from locally-owned mines to the port. The hijackings have been well-organized and quite ruthless. Hardest hit is the group supplying TriMark, and, through them, TriMark itself. This threatens the characters' chances to turn a decent profit on the venture.

The local Star Fleet officer, a pompous and incompetent lieutenant with a mere handful of men, is incapable of dealing with the situation. Moreover, he is about to recommend that the Federation reduce the number of potential trouble sources. His solution is to enact a new trade arrangement that would cut off small firms like TriMark, an even graver setback for the player characters. It should be plain to the players that if the hijackers are not found, and quickly, TriMark and their characters will suffer a large loss.

Investigations of the situation take the group onto Coridan's back streets, as they search for the truth. An Orion trader, smuggler, and rogue named Akalzed seems the most likely suspect for a time, but further digging turns up the fact that a Tellarite corporation, Grupharg, stands to gain a great deal from the hijackings. It seems that Grupharg will wind up with a virtual monopoly on Coridian crystals if the Protectorate decides to exclude the smaller companies. The player characters learn that Grupharg has been arranging the hijackings to assure this, and it is on the verge of success.

Learning the truth is not necessarily the same as proving it, as the adventurers find out. Having established Grupharg as the source of the trouble, they find themselves powerless until the Tellarites trip up. They are contacted by a Tellarite crewman who wants to turn over proof. A meeting is arranged, but turns into a dangerous encounter with Coridian thugs. The informer is killed and is unable to do more than warn the group that another hijacking is scheduled.

The adventurers have learned enough to realize that the next hijacking is likely to be directed at them, personally. TriMark plans to have the next cargo loaded directly at the mines, and the adventurers are supposed to transport it. These plans are known to the Tellarites, through blackmail of the local TriMark executive. The Tellarite leader sees this as a way to increase further tensions and eliminate an inconvenient group of meddlers at the same time.

The adventure climaxes when the Tellarites make their move. The outcome is completely dependent upon the skill of the players involved in the game and the abilities of their characters in the adventure. If the group has made preparations, they have a good chance at resolving the adventure successfully; they may also be able to call on reinforcements in the form of a zealous Star Fleet Midshipman or the colorful Orion pirate they once suspected of the hijackings. Details of the climax and resolution vary according to the flow of the game, but there are opportunities for a battle on board the group's small ship, and even a chase and a small-scale space battle, depending on how the gamemaster wishes to proceed and how the players react.

CONTENTS OF THIS BOOK

The separate encounters and episodes for this adventure are described in the sections of **The Adventure**. For the players' investigation of the hijackings, each of the most likely places and people they may contact or examine is discussed. The information in each section has a standard format for easy judging.

In addition, a separate background section gives details on Coridan and on the various companies and corporations that appear. Other sections include material on non-player characters, ships, and other items useful not only in this adventure, but also in other situations. Merchant characters are provided with enough detail to be used as player-characters, if the gamemaster and the players so desire, making it possible to play without first creating the adventuring group.

A section also is included that discusses two approaches to the adventure that the gamemaster may choose instead of the one intended. One has the players portray Star Fleet characters assigned to investigate the hijackings. The other has the players portray the crew of the roguish Orion smuggler Alemir Akalzed, who could easily rival Harry Mudd himself.

The Adventure

SETTING THE STAGE

Prior to the start of play, if this adventure is to be played independently of an ongoing campaign or if it is to be the beginning of a merchant campaign, the gamemaster should provide the following brief orientation to the players, giving them the background of the scenario.

The merchant transport *Two Brothers* is a *Mission Class* vessel recently purchased by the Captain, the Chief Officer, and the Chief Engineer, who have formed a partnership. Much of the capital for the venture came from the Chief Officer, who is fairly wealthy, with a large stock portfolio and many business contacts, but who lacks the skills to operate the ship effectively; hence the partnership.

The Chief Officer's contacts include a Terran businessman named Richard Jurgens, a corporate officer with TriMark industries, an industrial firm specializing in the manufacture of power systems and starship engines. Indeed, the Chief Officer owns TriMark stock and met Jurgens as a result of this ownership. The partners, having acquired their trading vessel, were in need of a starting point for their business, and it was Jurgens who supplied it.

Jurgens has requested the group to meet with him and his boss, Mark Calver, the president of the firm, at the company's main offices on Alpha Centauri. There, Jurgens has said, they will hear an offer that will be very much to their advantage. The adventure begins with this meeting.

A PROPOSAL OF INTEREST

The player characters will find both Jurgens and Calver dynamic and forceful, giving the impression that they plan to take TriMark right to the top. These men will give the characters a short background on the company, stating that it is a small company now, but already a profitable one, and they have every prospect of growing quickly in the face of recent developments.

Calver will tell the player characters that Coridan is an important source of dilithium crystals, and that it is currently being developed by local companies with the support of offworld firms. Jurgens will sum up the planet's history for the adventurers, as given in **Background Information**.

Having recapped these salient facts, the two TriMark executives will outline the current situation, and the bearing it has on TriMark. The adventurers will learn the following. In the time since the Protectorate was established, local industry has taken over Coridian mining operations, though not at a very high rate of production because manpower still is limited. Luckily, Calver will state, he has several friends among one of the leading mining firms, and TriMark Industries stands to gain a very profitable part of the Coridian dilithium exports. Agreements have already been signed, and delivery of the first loads will commence in another month. Control of a sizable chunk of the Coridian dilithium exports will give TriMark a major boost over its competitors. There are, it is true, several other concerns that have obtained similar deals, but only one of them, the Tellarite corporation Grupharg, is large and powerful. The Coridians have chosen, by and large, to deal with smaller operations like TriMark in the hopes of getting a fairer price and less chance of domination by some major industrial concern.

With the Coridian deal about to go through, Calver states, he is sending Jurgens to Coridan as his factor and planetary General Manager, to supervise details of the TriMark shipments. Because TriMark, an industrial firm, doesn't own its own trading fleet, carriers will be needed to transport dilithium shipments from Coridan to Vega. Vega is only 9 days from Coridan at Warp 7, and it is on the main trade routes; hence is an ideal base of operations. Thus, a TriMark manufacturing plant is being opened there to take advantage of the Coridan deal.

Calver will offer the adventurers a 6-month charter. Because TriMark is in the process of several major expansions such as the new plant on Vega, and thus cash is tight, the company would like to avoid paying the usual high price of shipping until their capital will be available for a more normal arrangement. Instead, they will offer a combination of cash and TriMark stock. During the length of the charter, the *Two Brothers* is to carry dilithium shipments from Coridan to Vega, and certain manufactured goods back. Through that period, TriMark will pay all operating costs in cash, including the monthly payment on the *Two Brothers*. However, the group's profit, including salaries for all crew members, will be paid at the end of the charter with 1500 shares of TriMark stock. The stock currently is worth 65 credits per share, and it could rise considerably by the time the 6-month deal expires.

The TriMark offer isn't spectacular, but it does have much to recommend it. First, the group will have 6 months in which operating expenses won't be a concern. This will give them time to get their bearings, and will allow them to use sub-space radio to promote other possible deals or exploit worthwhile connections. Second, the pay-off is a reasonable one, and, if the company prospers as expected, it could turn out even more rewarding in the end. Finally, the offer makes it possible for the group to begin making some personal contacts on Coridan and Vega, which could stand them in good stead when the TriMark charter ends. Furthermore, there is also the chance that good performance will give the group an inside shot at making the TriMark connection both more solid and more lucrative after Calver has more money on which to operate.



If the players think to negotiate, a successful Skill Roll against their spokesman's rating in *Negotiation/Diplomacy* use may permit them to obtain a slightly better deal. An advance of 15,000 Cr. can be obtained immediately, over and above ship's expenses, for the use of the crew; this will reduce the ultimate stock payment to 1400 shares, but the overall value is still better for the group.

If the player characters agree to the deal, contracts will be signed. The stock will be placed in escrow pending completion of the 6-month contract. The player characters will be required to transport Richard Jurgens immediately to Coridan, a flight of nearly a month at Warp 7; by the time they arrive, the first dilithium shipments should be nearly ready to go.

FLIGHT TO CORIDAN

The best way to handle the characters' departure is to require them to designate power allocations, armed weapons, shield status, and so forth. If they have the habit of doing this during all lift-offs and landings, so much the better. They will be accustomed to being concerned with such information on a regular basis, so that the gamemaster will not call attention to these facts at times when (such as in *Hijacked!*) it is important. It avoids the possibility of having the ship's shields raised just because the gamemaster chose to ask if they were!



The flight to Coridan will be long, but uneventful. Jurgens' presence will make things cramped, but not impossible; two crewmen will need to sleep in shifts to give Jurgens a place to stay.

During the flight, Jurgens will keep very much to himself. He will be friendly enough, but he will spend much of his time working on a mass of computer-stored paperwork, and his off-time in a variety of solitary pursuits, including calisthenics, reading, 3-D chess problems, and studying an instruction tape on the Tellarite language. If queried about the language, he will state that he already speaks it fairly well, having been in the service of a factor on Tellar in his early days in business. If any of the crew expresses an interest, he will play 3-D chess games from time to time, but otherwise he will not mix much.

At long last, Coridan will draw near. After obtaining clearance from Coridan starport control, the *Two Brothers* will land. Having delivered Jurgens to Coridan, the adventurers will be told to wait until he has instructions regarding the first shipment of crystals. They will be told that this should take no more than a week to prepare; in the meantime, they will be free to spend their time in port as they desire.

AT CORIDAN STARPORT

The characters will find that Coridan starport facilities are not particularly extensive, being primarily intended to handle the rather limited traffic to and from Coridan's one major city, which has a population of less than 250,000. They will see in progress expansions of the port facilities, but even with the increase in trade under the Protectorate, the port will not be particularly crowded. Only a handful of ships will be in port, including the robot ore-freighter *Vishnu*, out of Deneva, the Tellarite trading vessel *Gavikugh* (owned by Grupharg, TriMark's rival), a small Vulcan vessel with a name that defies Human pronunciation, and the Orion-owned *Roulashakballih* (translatable roughly as *Rogue's March*). Of the few other ships present, none will be of any great interest. It should be made clear to the players that there are no Star Fleet vessels at Coridan, either in orbit or on the ground.

SAMPLING THE NIGHT LIFE

For several days, the adventurers may do whatever they please. There is nothing stopping them from sampling Coridan's night life (such as it is), from shopping for equipment, or from looking for useful contacts. It is up to the players to determine what, if anything, they wish to do to fill their time while they wait for word from Jurgens. Starport officials will be friendly and helpful, giving directions to entertainment spots in town or any other help requested.



The Tellarites on the *Gavikugh* will not be very approachable. They do not mix with anyone in port, and they will grow abusive and insulting if anyone seems inclined to call on them.

The Orions, on the other hand, will be quite friendly. The Captain of the Orion ship, the suave and flashy Alemir Akalzed, will deliberately look up the adventurers, offering to personally take them out to a nice nightspot he knows. If the player characters accept, he will spend a great deal of time hinting at the joys of owning an Orion slave girl.

FIRST SIGN OF TROUBLE

During this time, the group will be exposed to rumors of various kinds. Talk of the hijackings is common in the starport and in town, and the adventurers are sure to hear about the situation. They will find that many feel that with 15 people killed recently, "the old days of illegal mining look good by comparison." They will discover that, in the course of the past 2 months, 4 dilithium shipments mined by local companies have been hijacked openly, all with a similar pattern. In each case, the shipment was in transit from the mines to the city, there to be shipped off-planet. Each was hit with almost-military precision. In every case, no survivors were left behind to tell who had done the deed, or how. The most recent incident, a week ago, took place despite the presence of a private security force hired to guard the shipment in question.

Akalzed will make his view of the situation on Coridan clear early on. "There is no difference," he will say, "between Coridan now and Coridan before the Babel Conference – except that what was merely reprehensible before is now technically classified illegal, instead. You can perhaps picture my shock and dismay at finding that I was a criminal, when all along I thought I was merely a self-seeking adventurer." He will make no bones about his own past as a dilithium smuggler, though he will claim that he 'naturally' does nothing of the sort now.

Locals will meet queries about Star Fleet presence with derisive laughter. The reason for this laughter will become evident when it is explained that Coridan's Star Fleet presence is a Planetary Observation Unit (POU) headed by Lieutenant Winter, a young and inexperienced officer. The unit consists of one Midshipman and 12 enlisted personnel with more work to do than they can cope with, even under routine conditions. The POU is woefully unprepared to do anything, and most Coridians consider it a worse-than-useless response to their original request for help. True, they now have legal recourse in the event they catch illegal miners, but they still have very little aid in catching the wrongdoers in the first place.

THE NEWSCAST

Four days after landing, the group will see a newscast of considerable importance. The opening text is reproduced below.

"Late last night, another shipment of dilithium crystals, the fifth in the last 63 days, was hijacked while in transit from a mining site in the Colsitar Mountains to the capital city.

"As in all the previous incidents, the shipment was intercepted by some unknown assailants, who slaughtered the Coridian miners driving the ground-effect transport vehicle carrying the crystals. No clues regarding the identity of the hijackers have been found.

"This shipment is the third hijacked cargo mined by Tarsine Minerals, and consigned to the offworld firm TriMark Industries. The other two hijackings were apparently unrelated, except in the style and execution of the crime. Investigators do not know if the Tarsine-TriMark connection has any special significance. Neither company's representatives would comment on the matter.

"Lt. Joseph Winter, Star Fleet's Planetary Observer on Coridan, has announced his intention to take steps to reduce the chances of future hijackings, but failed to specify what these steps might be. In view of the POU's past performance in the areas of shipment security and Protectorate law enforcement, most people we spoke with were inclined to doubt the effectiveness of any new steps Star Fleet might attempt to implement at this time."



The newscast will go into additional detail regarding various local reactions, theories, and protests. It will report that, in the general view, the Orions are responsible. An interview with Akalzed will be shown, in which the Orion captain laughs off the accusations, but doesn't actually deny them. After the interview, several claims of Orion interests in Coridan, the precision and ruthlessness of the attacks, and similar circumstantial evidence will be advanced to support these speculations.

CONDUCTING AN INVESTIGATION

From the newscast the players will learn that TriMark has lost three shipments recently. This constitutes a threat to their charter, and substantially increases the chance that, even if the company lives up to its contract, the stock they have agreed to take in payment will lose value if the Coridian venture fails. They should know that their margin of profit is entirely too narrow to allow such a turn of events.

This brings the adventurers to a decision. They can do nothing, or they can take matters into their own hands. Their discussions with locals should have revealed to them that local investigations likely will not get anywhere. Furthermore, they have a strong motive (the value of their stock payoff) to want to see the crisis on Coridan ended, and it might be in their best interests to take matters into their own hands, making an attempt to uncover the truth of the hijacked shipments and put an end to them once and for all.

It should be made clear that the adventurers are not required to investigate matters on Coridan. This should be a decision that they choose to make, not something thrust upon them.

If they choose not to look into the hijackings, several days will pass, and then the events described in **The Crucial Shipment** will occur. Without doing any investigation on their own, the players may be ill-prepared for the situations arising in that climax to the adventure.

If, as is more likely, the players choose to have their characters look into the hijackings privately, they will have complete control over the directions the inquiries will take. As the investigation proceeds, the players will choose to investigate certain places or to interact with non-player characters. **Hints On Play** provides a section detailing how the gamemaster can judge the results of the encounters.

STARPORT ADMINISTRATION

The adventurers may wish to consult the starport records to determine various bits of information concerning shipping schedules, vessels in port during the period in question, and so forth. Starport records are, for the most part, public, and could provide a basis from which to work. Any character who requests the data may be given 3 items of information.

First, port records show that none of the ships now in port has been present for the entire period of the hijackings. The Tellarite ship visited once 80 days ago, spent 10 days in port, and then departed. It returned 8 days ago and is still present. This is the first recorded visit for the *Roulashakballih* for over a year, though it was a fairly frequent visitor prior to that. Two other Orion ships have been in port in the last two months, but the times do not jibe conveniently enough for a definite correlation to be made between Orion ships present and the hijackings.

Second, the *Roulashakballih* has filed a cargo declaration showing a mix of various cargos, almost everything except dilithium crystals. The declaration amounts to perhaps 3000 SCUs, with no other cargo declared, which means Akalzed plans to travel with half his hold empty... or is planning on carrying items not listed on the manifest.

Third, *Gavikugh's* cargo manifest was recently withdrawn. It was scheduled to lift 3 days ago with a load of dilithium crystals, but a hijacking hit its intended cargo, and the Tellarites are waiting for a replacement cargo from Descale Resources, Inc., the mining firm with which they are doing business.

By a successful application of a character skill in *Administration*, further inquiries will reveal an additional bit of information. When *Gavikugh* was last in port, she left behind five Tellarite advisors to assist Descale in their mining operations. Thus, these five Tellarites have been on the world throughout the entire period of the hijacking incidents. The gamemaster should neither play this up nor attempt to suppress it, and should not interfere in whatever conclusions the group wishes to draw.

RICHARD JURGENS

Jurgens will be in a very ill humor when any adventurer calls upon him, and especially if the adventurers come to him more than once with questions on the hijackings. He grudgingly will supply records of the lost shipments: 30 days ago, 100 SCUs lost; 23 days ago, 125 SCUs lost; and, in the most recent shipment, another 125 SCUs lost. This amounts to over half a million credits lost by Tarsine Minerals, a blow which that company can ill afford. This also represents a major setback to TriMark, because these crystals were needed to complete several important TriMark contracts.

Jurgens will indicate that arrangements for another shipment are being made now, and that he will contact the group when he needs them. Furthermore, he will make it very clear that he does not want them to meddle further in the matter.

Indeed, further questioning of Jurgens will prove costly. He will become angry, and threaten to revoke the *Two Brothers'* charter contract if the player characters continue to pry. If he is pushed hard enough, Jurgens will carry through on this threat, though the gamemaster should make it clear that the man plainly has something to hide. This information should be provided in such a way as to encourage the group to keep looking into the matter, even after it seems as if they can kiss their stock goodbye. He might even plant the suggestion that the player characters could win the support of Calver if they uncover evidence of a coverup by Jurgens.

Suspicious characters might attempt to keep a close eye on Jurgens, but they will find his movements perfectly normal. He will spend his days in a small office not far from the starport, and his nights at a room he has taken in a small hotel nearby. If the group thinks to plant a listening device in his office or room, they may learn additional information. Planting a bug requires access to materials (125 credits will buy everything needed, with more money increasing reliability), an opportunity (up to the gamemaster to create and judge). The characters will need to use skill in *Security Procedures* averaged with *Streetwise* to hide the bug successfully. Once the bug is in place, one character must use his skill in *Electronics Technology* to set up the monitoring system. More expensive components will give a favorable modifier.

There is a 25% chance each day that Jurgens will place a call to an unidentifiable location, speaking in Tellarite to the person who answers. Only Jurgens' side of the conversation will be clearly heard. Only someone with a rating of 10 or more in *Tellarite Language* will be able to translate the message, learning that Jurgens is passing on information concerning the security arrangements of Tarsine Minerals shipments. Jurgens' manner will be apprehensive; it will be clear that he is being coerced into giving the information through some form of blackmail.

A confrontation with Jurgens after such a conversation will produce a confession that he is being blackmailed by a Tellarite who knows of a past indiscretion in his business life. This Tellarite has guaranteed that Jurgens will profit from a betrayal of TriMark, but that he will be utterly ruined if he attempts to back out. Jurgens will state that he has no idea who the Tellarite is working for or why the dilithium crystals are being hijacked, has never actually seen his contact, and is actually very much in the dark about the whole situation. Once confronted, he may agree to cooperate with the adventurers if it looks as if they will be able to extract him from the tightening circle of intrigue in which he is enmeshed.

STAR FLEET

Lt. Winter will not be available to discuss anything with the group, but his assistant, Midshipman Karen Morrow, will be willing to answer routine questions. Though young and untried, having just been posted to this planet as her Cadet Cruise, she will seem bright and capable.



She will tell the player characters that the Planetary Observation Unit has made no progress in tracking down the source of the hijackings, or a motive behind it. It is, as Morrow will put it, impossible for 14 people to police a planet.

More importantly, Midshipman Morrow will reveal that the 'steps' Lt. Winter plans to take have nothing to do with finding the hijackers. She will tell the characters the following details of Winter's plan. He has filed a recommendation to Star Fleet (which is very likely to be endorsed, thanks to political considerations) suggesting that offworld shipping be limited. He proposes to eliminate the small-time companies, the Orion traders, and other complicating factors. A handful of larger shipping lines will be given contracts to haul crystals for everyone, and the scramble for competition between offworld-backed local companies will be reduced. His proposal states that this will remove the source of the hijackings.

Morrow will tell the adventurers that Winter believes the hijackings to be the work of the Orions. She will relate Winter's arguments that the Orions haven't been able to get local contacts such as those the various Federation groups have set up, and so they want to upset things and profit from the confusion. She will confide to the characters that Winter's recommendation is not his own, reminding them of the following facts. The proposal is almost word for word that advanced by Ambassador Khark of Tellar during the Babel Conference. Khark's proposal had a wide scattering of support; Sarek of Vulcan (who proposed the approach actually adopted to setting up the Coridian mining industry) was able to overcome Khark's movement only with difficulty. It is well known that many of the Vulcan ambassador's adherents have lost enthusiasm in the period since the original conference, largely because Coridian development lagged far behind expectations even before this current problem cropped up. Morrow will imply, though not state, that Winter chose to make his recommendation because he knew it was likely to be endorsed by a majority of those concerned.

A successful application of *Negotiation/Diplomacy* skill when dealing with Morrow will reveal one additional, crucial fact: there is already a proposal under consideration by which a single firm would be made responsible for guiding Coridian economic development for the next several years. That firm is the Tellarite company, Grupharg, which has always maintained a strong interest in Coridian mining. It is fairly certain that the proposal will be passed in light of the hijackings. This, in turn, will lead to other firms being excluded from direct dealings with Coridian mining companies and give the Tellarites virtually a legal monopoly over the Coridian dilithium crystal resources.

THE ROULASHAKBALLIH

Akalzed is so friendly and affable that it will be relatively easy to approach him and his people in the hope of obtaining information. The Orion will invite members of the group aboard and willingly show them around his ship. While on the tour, the adventurers will notice that among the Akalzed's mixed bag of crewmen are a Human female, an Andorian, and a Tellarite.

Very little information will be gained without specific skill use, as Akalzed will not specifically point out any of the modifications to the *Roulashakballih*. Nevertheless, the adventurers still have a chance to learn more than the Orion may plan on giving away about his activities. A successful application of *Astronautics* skill while on the tour will enable a character to spot that the Orion impulse engines should take up much less space than they do, leaving quite a bit of space unaccounted for. This could convince the players that the Orion ship (like their own) has been fitted with a secret hold for smuggling purposes.

Further investigation may take several different forms, from a stealthy burglary to a direct confrontation. The gamemaster must resolve the situation as the players determine their course of action; if Akalzed is openly confronted, he will cheerfully admit that there are some modifications. He'll first show off the weapons section of the ship. Even so, characters who have already discovered the unaccounted space may reapply the skill of *Astronautics* to recognize that the addition of the weapons still leaves a great deal of empty space. Again, if directly questioned, Akalzed will laugh, congratulate the characters on their insight and persistence, and show them his hidden cargo bay. He is carrying contraband, but the contraband is a load of electronics equipment, including life support belts, Star Fleet issue communicators and transponders, and a number of other items of hardware not generally available to civilians or members of non-Federation powers. He acquired this equipment from a source he has on a nearby world, and is simply passing through Coridan as part of the route for his more legitimate trading activities. No sign of smuggled dilithium crystals will be uncovered by any type of search.

THE GAVIKUGH

By keeping a close but subtle watch on the Tellarite ship, the adventurers will discover that Descale is delivering a few cargo containers loaded with crystals each day, but all seems quite open and above-board. The Tellarite crewmembers mostly will stay around their ship, except for two of them, who will be seen frequently in Descale vehicles. If followed, these two invariably will go to the Descale offices in town.

Face to face, the Tellarites will not be nearly as cooperative as the Orions. In fact, the adventurers will find it very difficult even to get close to the ship. This should not be portrayed as something particularly sinister, but merely that the Tellarites just do not invite much contact.

If the adventurers persist in making contact with the Tellarite crew, the Tellarites will get loud and abusive toward anyone who comes close... but then Tellarites are always loud and abusive. No information will be available from such contact. The Tellarites will keep themselves very much to themselves, and no amount of ordinary friendly inquiry will help.



During contact, successful application of a character's *Negotiation/Diplomacy* skill will permit him to confirm facts available elsewhere. They will be able to verify that two of the crew stayed behind as advisors to the Descale mining operations, and that a cargo intended for them was among those hijacked.

Efforts to breach the security of the *Gavikugh* and enter it must be resolved by the gamemaster, but the chances of such a breach are slim. Very clever plans might get members of the group on board, but even so they will discover nothing of particular interest.

DESCALE RESOURCES

The office of Descale Resources, Inc. will not be a particularly fertile ground for investigations. The staff will be polite but unhelpful. They will seem to recognize the adventurers as the crew of a ship in the indirect employ of a competitor, and so they will refuse to share information on the hijackings or much of anything else.

Should the adventurers use bugs or stage an illegal break-in, they will discover the fact that the shipments being loaded aboard the *Gavikugh* do not jibe with shipments being received from the company's mining operation. The information will be fragmentary and subject to several possible interpretations. It may be evidence of wrong-doing, or it might merely prove that Descale had some crystals in storage and are now using them to replace the lost shipment. The bits and pieces of conversation or documents that will be discovered connected with this matter will point in either direction.

Successful application of *Administration* skill will turn up the fact that all security and shipment arrangements were worked out more than 3 months ago between Jurgens and the president of Tarsine.

TARSINE MINERALS

Looking into the background of Tarsine Minerals, the TriMark connection on Coridan, will be the opposite of such an investigation of Descale Resources. The staff will be helpful, cooperative, and, in fact, more friendly than the group's employer, Jurgens. However, they will have very little information of value to the group's investigation.

THE STREETS OF CORIDAN CITY

Characters who take to the streets in search of information will not find any information automatically. Successful application of a character's *Streetwise* skill, with one Skill Roll allowed for each day of search, will uncover the interesting information that a number of local thugs and bully boys have dropped out of sight over the last 2 months. They are not believed to be dead; the talk on the streets is that these thugs are the muscle for the hijackings. No one, however, will seem to know where they might be found or who is employing them.

CIRCUMSTANTIAL EVIDENCE

The adventurers can certainly establish Grupharg's plot, described in the **Gamemaster's Notes** section, through sound reasoning and a careful look at all the clues they can uncover. They do not, however, have any concrete evidence.

If the characters press the local authorities for action, they will find that the authorities will not act against the Tellarites on the say-so of a handful of off-world traders. Offworld matters are under Star Fleet jurisdiction.

If the characters bring their suspicions to the POU, they will find that Lt. Winter is unwilling to go out on a limb in a situation such as this, either. Midshipman Morrow can be convinced that the group is correct, and she will be willing to take action even against her superior's orders. She will do as the characters wish, but she will have only one chance to make it work.

If the group decides to rush in with Morrow's support to raid the *Gavikugh*, they will be sadly disappointed. There simply will not be any evidence of wrong-doing aboard. Such a premature move will mean Morrow's ruin, and likely will result in some very damaging legal action directed at the adventurers.

The gamemaster should not prevent such a move, if the group really wants to try it. He should keep in mind the consequences of their actions and be willing to implement events reflecting these consequences. The group may be able to overcome the setback and solve the problem, but, in doing so, they will have additional handicaps to overcome if their initial reactions were hasty and poorly planned.

The gamemaster might give help to players who are not thinking things through, hinting about the possible outcomes that they should be considering. He might ask for a Saving Roll against INT to give them some of the possible consequences that they overlooked, or, if they are making a really deadly mistake, against LUC to have events work in their favor. 'Good luck' need not be obvious to the players at the time. The adventurers could be forced to tend to business (see **The Critical Shipment**) instead of executing some dumb move. They could get into a mess and discover that Midshipman Morrow has had second thoughts, leaving them high and dry but preserving her usefulness as back-up for the real climax. Anything the gamemaster cares to do to nurse events toward a satisfying conclusion is perfectly acceptable.

A SOLID LEAD

Soon after the group has realized the nature of the situation, and is beginning to wonder how to gather proof of the Tellarite complicity in the hijackings, they should be presented with what seems to be an excellent solution to their problem. They will receive a message aboard the *Two Brothers* that promises to break the Tellarite plot wide open.

The nature of the message is up to the gamemaster, depending on the circumstances. The best choice would be to have it be a viewphone call received and recorded by the ship's computer while the group is out investigating somewhere. If the adventurers are not leaving their ship unoccupied, however, it could equally well be a face-to-face call. In this case, though, the caller plainly will be in haste and will not elaborate on his message. The message's contents will be the same, regardless of its nature.

The caller will be a Tellarite, recognizable as a member of *Gavikugh's* crew. He will be breathless and nervous, speaking in an uncharacteristically subdued voice for a Tellarite. He will state that he has information about the hijackings, and that he knows that the adventurers are interested. He requests that they meet him behind the the Descale warehouse that night at 2400 hours standard. His parting statement, just before he clears the screen, is that the characters' lives are in danger.

Two possibilities present themselves, of course. He might be legitimately ready to talk, or he might be setting a trap. But in either eventuality, the Tellarite offers a solid lead that the adventurers can hope to exploit. To ignore the lead would be foolish, and so it is likely that the adventurers will meet the Tellarite as requested.

How they choose to go about this is up to them. They may wish to take elaborate precautions against a trap. The gamemaster should allow them to plan things as they desire, taking into account the extent and wisdom of their plans in the course of events that follow.



THE ASSASSINATION

All will seem quiet and deserted when the group arrives. The time of the meeting will come and go. The Tellarite will appear 10 minutes late. If the group stays around, they will meet him. If they leave before he arrives, events will go somewhat differently.

In the first case, he will show up panting for breath and casting nervous looks at every shadow. When the characters make their presence known to him, he will be startled, but he will quickly realize that it is the adventurers, and not an enemy. He will be almost incoherent with relief, a stream of words pouring forth from which the adventurers will be able to catch only a few disjointed phrases, such as "There have been too many deaths already" and "I can't live with the thought of what we've been doing." The Tellarite's relief will seem quite genuine, but precious minutes will be wasted before he calms down enough to talk, and those minutes will prove to be crucial.

If the adventurers have guards posted to warn of danger, they will receive some advance notice of trouble; if not, they will be taken totally by surprise. A gang of Human thugs and thugs will appear at either end of the alley, and will move toward the adventurers. There will be 12 of them, residents of Coridan armed with a motley variety of knives, stun clubs, old lasers, and a few phaser weapons.

Use the map of the alley provided to resolve the fight with standard combat rules. Player-characters who have kept themselves hidden will not be noticed by the attackers, giving them a chance to strike with surprise. The fight should be staged strictly according to the personal combat system, with the outcome dependent on how well the player-characters conduct themselves.



One event, however, is mandated. In the middle of the fight, one of the phaser-armed thugs will fire at the Tellarite, and hit. The phaser will be on disrupt, and the Tellarite will take lethal damage. The chances of saving him will be slim. Judge this with the normal rules for medical treatment and recovery. The player characters do not have a starship sick bay to work with, and skill in Tellarite medicine is unlikely to be common on Coridan.

Before he dies or passes into unconsciousness, the Tellarite will be able to gasp out a few last words to the nearest character. "One more hijacking... mining camp... your ship... know about decoy..."

The rest of the battle can go either way. The thugs will be concerned primarily with eliminating the Tellarite, but they will have no scruples about wiping out as many adventurers as they can while they are at it. Unless the players are criminally stupid (in which case, they deserve whatever they get!), they should have an easy time taking the honors in the fight and driving off or capturing their assailants.

Captured thugs will know nothing of the hijackings. They will provide the player characters with the following information. They were hired by a Coridan who is well known as a local hoodlum, but he did not say why he wanted them to kill the Tellarite or attack the group. It was strictly a business arrangement; the gang was told the time and place of the meeting, ordered to eliminate the Tellarite and as many others as they could, and promised a payoff when the work was carried out. They do not even know how to get in touch with their employer; he is to contact them, at some unknown time, to arrange the payoff.

The local constabulary will handle the problem once the adventurers are satisfied they have learned everything they can. The group will be subject to close questioning over the incident, but eventually they will be permitted to go about their business.

Hard on the heels of this encounter, events will begin accelerating to a climax.

WORD FROM JURGENS

If the group does not bother to investigate matters on their own, play will skip to this point after an interval of several days. Jurgens will contact the adventurers, informing them that a shipment is ready to be transported and will set them up as described below. The player characters will have no particular reason to suspect that this is a set-up, nor will they have reason to believe their employer is involved.

Jurgens will be very matter-of-fact, telling them the following details of the plan that Tarsine Minerals has worked out to forestall further hijackings. Ground-effect trucks will haul a load just as usual, but it actually will be a number of empty boxes and some concealed representatives of the constabulary. The *Two Brothers* is to land at the mine site and load the cargo there; a special exemption to local landing regulations has been granted for this purpose by the planetary authorities and countersigned by Lt. Winter. It is Jurgens' hope that TriMark will get its shipment and the hijackers will fall into a trap at the same time.

If the group has conducted an investigation of their own, things may turn out differently. Four possibilities exist. The player characters may not have found out about Jurgens' part in the hijacking. They may have found out, but not recruited Jurgens. They may have found out about his complicity and recruited him. They may have pressed him too hard, and their contract with him may have been terminated.

If they are still working for Jurgens, they will be contacted by him early in the morning after their meeting with the Tellarite. The details that he gives them will depend on whether or not he is working with them. If Jurgens is not aware that the group has uncovered his part in the plot, or if they have not done so, the details will be just as though no investigation had occurred.

Should Jurgens have been recruited by the player characters, he will admit that these orders are part of a set-up, giving the adventurers the following details. The hijackers know the arrangements, and plan to take the *Two Brothers* after the cargo has been loaded. They plan to beam aboard using a transporter control transponder that Jurgens is to incorporate into the crates. This is to occur shortly after the ship takes off. Thus, with Jurgens' cooperation, the group will have the perfect chance to turn the tables on their assailants and stage an ambush of their own.

Should the adventurers have been fired from their charter by Jurgens, the gamemaster has two options. One option is to have the executive approach them again, apologize, and offer to renew the agreement. If they accept, the play will continue as described above.

The other option is to have Jurgens approach Akalzed with a charter offer. The Tellarites could plan to board *Roulashakballih*, take the ship, and make the disappearance look like an Orion theft. In the latter case, Akalzed will contact the adventurers, knowing their interest in the matter. He will wonder aloud why anyone should suddenly trust an Orion with a cargo of dilithium crystals when accusations have already been aimed at him. A cooperative arrangement can be reached where the *Two Brothers* is prepared to assist Akalzed in case there is any trouble.

If Jurgens is working with the player characters, the group may use this new contact to arrange whatever extra advantages the gamemaster wishes to allow.

LOADING THE CRITICAL SHIPMENT

What the characters learn from this encounter will depend on the outcome of **Word From Jurgens**. Whether it is the *Two Brothers* or the *Roulashakballih* that will make the pick-up, the ship will be asked to take on cargo the following day. The loading will take place at the mining camp in the Colsitar mountains, several hundred miles west of the city.

The *Gavikugh* will lift off a few hours ahead of the scheduled departure by the *Two Brothers* or the *Roulashakballih*.

If the players forget, remind them to designate their power allocation, their weapon and shield settings, and so forth, before they lift off. After their own departure, the adventurers will need only a short flight to get them to the mining camp. They will find Jurgens there, supervising the loading operation. If he is an ally, he will share what information he has, giving them the following details.



He will repeat that the hijackers plan to beam a party on board *Two Brothers* shortly after the ship takes off. He will show them the transporter control transponder, which will enable the hijackers to lock onto the cargo hold at any time. He will not be able to tell them anything about the intended size of the boarding party or about any other intentions or plans relating to the hijacking. He still will have no proof that the *Gavikugh's* crew is behind it, but just that a Tellarite is involved.

If Jurgens is not an ally, he will not reveal the presence of the transponder device. Nevertheless, it may be noticed by two different characters.

The character handling the ship's communications during and after the loading process should be asked to make a Saving Roll against his LUC score. If the roll is successful, he will notice an odd signal. A successful application of his *Communication Systems Operation* skill will allow him to determine just what is making the signal.

The Engineer also should be asked to make a Saving Roll against his LUC score, with a penalty of -20 to the score. If he is successful, he will notice the signal while securing the ship for lift. A successful application of his skill in *Electronics Technology* will allow him to locate the signal's source.

HIJACKERS

This is the climax of the adventure, towards which all other events should lead. If they know of the set-up, the player characters will have had time to make arrangements for support from Midshipman Morrow and Star Fleet or from Akalzed.

The gamemaster should be sure to have the players indicate their power allocations, weapon settings, and particularly shield settings. In this encounter, the shield status is very important.

If the adventurers are expecting a hijacking attempt, they will probably be prepared for it, and will want to leave their shields down during the flight to invite attack. If, however, the shields are up as the adventurers head for orbit, the group will receive a call from Jurgens on the surface. He will state that he has forgotten to give them a pouch containing some contracts and other business-related information that must go to Vega along with the dilithium crystals. He will ask the *Two Brothers* to beam him aboard so he may deliver it.

If the adventurers keep up shields at all times, refusing to run any risks, they will be safe. The *Gavikugh* will not do anything so blatant as attack them! This will be an uneventful ending to the adventure, and perhaps the gamemaster can find a way to stage some further action on the ship's next visit to Coridan, if the Tellarite monopoly isn't already in force by that time to eliminate the entire TriMark venture.

Naturally, if the adventurers drop shields to bring Jurgens aboard, the Tellarite boarding party will be beamed into the cargo bay at the same time. The attack will begin before the *Two Brothers* reaches orbit. The Tellarites want it to be evident that this is all part of the pattern demonstrating Coridan's inability to protect itself from this sort of trouble, so it must occur in the world's jurisdiction.



The combat aboard the ship can be resolved according to the usual combat rules. Six attackers will be beamed into the cargo hold, each armed with phaser I-A weapons. Five of them will be Coridian thugs; the sixth will be a *Gavikugh* crewman, whose function will be to fly the ship once it has been taken. The hijackers will want to gain control of both the bridge and the engineering section before the ship reaches orbit. None will attempt to take prisoners.

the cargo hold, each armed with phaser I-A weapons. Five of them will be Coridian thugs; the sixth will be a *Gavikugh* crewman, whose function will be to fly the ship once it has been taken. The hijackers will want to gain control of both the bridge and the engineering section before the ship reaches orbit. None will attempt to take prisoners.

The course of the boarding action will depend largely on how the adventurers choose to react. If the group has been expecting the attack, they may be prepared in various ways for the action. Perhaps a couple of people will be hidden in the hold, such as in the smuggling compartment under the stairs. With such an action, the fight probably will be over fairly quickly.

On the other hand, if the player characters are taken by surprise, they will be in more real danger. Fights in either the bridge or the engine room could easily be dangerous. Damage to some vital control or engineering console would be likely, and virtually inevitable if the combat took very long to resolve.

Combat resolution is strictly up to the gamemaster, using the rules as his guide and the players' plans and reactions as his starting point. The boarding party could be captured or killed. A random phaser shot could cause the player characters to lose control of the ship and require them to use their skills to keep it from crashing.

The gamemaster should seek to build an exciting, tension-filled climax to the scenario. If he thinks saving the ship will make a satisfying peak to the excitement of the scenario, he should engineer this. If, on the other hand, this is not reasonable given the players' actions, then even capture of the boarding party or salvation of the ship from a crash does not necessarily end the adventure. In this case, the gamemaster should use **Encounter In Space** as the climax.

ENCOUNTER IN SPACE

The Tellarite will be recognized as a member of *Gavikugh's* crew. Dead or alive, his presence among the hijackers is ample proof of the plot the adventurers have uncovered. Nevertheless, the Tellarite ship might still escape, and the gamemaster could encourage the players to consider ways of taking it before it can do so, despite the disparity in size. If *Midshipman Morrow* is involved at this point (it's certainly possible that she and other Star Fleet personnel might have been invited to help arrange the ambush), she will push for an immediate follow-up to the initial success.

The adventurers may make a move against *Gavikugh* using one of several plans. The most direct is a flat-out pursuit; *Two Brothers* is faster, and could catch up even if the other fled. However, *Gavikugh* is just well-enough armed to make such a course of action a risky one.

A more subtle approach might involve the pretense that the capture has been successful. If the Tellarite captive is still awake and feeling talkative (the latter depends on the gamemaster's evaluation of just how threatening the adventurers are being at the time), he might be persuaded to reveal what plans he had for the captured ship. If he talks, he will give the player characters the following information. He was to establish contact with *Gavikugh* and make an orbital rendezvous. The cargo was to be transferred with the ships on the far side of the planet from the city, where no skywatch is maintained to monitor vessels. Then, the *Two Brothers* was to be crashed in a spectacular fashion so that the hijacking would be known.

If the players act on this information, the gamemaster must determine whether or not the Tellarite captive is willing to cooperate actively (as in giving the proper signal establishing contact, for instance). To help him make this determination, the gamemaster could roll percentile dice. On a roll of 01 – 20, the Tellarite will actually comply, seeing no further reason to resist. On a roll of 21 – 40, he will indicate an apparent willingness to cooperate, but, at the first opportunity, he will attempt to tip off his fellow Tellarites to enable them to escape. If a Star Fleet officer is present to offer immunity in return for cooperation, a –15 modifier may be subtracted from the die roll. Other modifiers may be assigned as desired, to represent the effects of various other means of persuasion that might occur to the players.

If they attempt trickery, the player characters will rendezvous with the *Gavikugh*, which will lower shields to beam over cargo handlers. When the shields go down, of course, the adventurers may attack.

With a single starship weapon available, the adventurers will not be in a position to do much sustained fighting. Without a preemptive strike, the *Two Brothers* on her own will have little opportunity for fighting. It is fully possible for the Tellarite ship to raise shields enough to hold off the tiny transport and still attempt to escape. The *Two Brothers* can stay with the Tellarites, risking damage from the *Gavikugh's* heavier armaments, but it will not be able to do more than irritate the Tellarites.

Because they will be in close orbit, however, the player characters can use a preemptive strike to make the most of their limited firepower when the *Gavikugh* lowers its shields. A successful Skill Roll to lock phasers on target, made against a character's rating in *Starship Sensors*, may be followed by a Skill Roll against the firing character's rating in *Starship Weaponry Operation*. If this second roll is successful, the character can designate the damage location for that hit. This would permit the first shot to take out the Tellarite shield generators, thus giving the adventurers a telling advantage.

If no preemptive strike occurs, and the players have not already planned around the problem of dealing with the *Gavikugh*, the gamemaster should permit a 'cavalry to the rescue' ending, with the appearance of the *Roulashakballih*. Akalzed has been following the events with interest, for he is displeased with the Tellarite actions that threaten to implicate him. He can turn up as the adventurers realize they cannot hope to crack the Tellarite defenses. Shooting together, the Orion's disrupter and the *Two Brothers'* phaser can match the power of the other ship's shields, and *Gavikugh* cannot hold out against the combination as effectively as she could against the adventurers alone. If the Tellarites accumulate more than four hits, they will surrender.

ALTERNATIVES

There is no certainty that events will unfold as described here. Various different paths may be taken (too many to allow thorough descriptions of them all). It is up to the gamemaster to regulate the actual flow of events.

For example, suppose *Roulashakballih* is to haul the cargo because Jurgens fired the adventurers for meddling too much. Akalzed, suspecting a trap, recruits the adventurers to assist him. In this case, the *Two Brothers* must come to his aid, rather than the other way around. The space battle would be an absolute must for this course, because the adventurers would miss out on the boarding action and such difficulties. The gamemaster can make things look tense by having the Orion ship outmatched; perhaps a shield generator control was damaged in the boarding action, leading to a situation in which Akalzed is badly outclassed. Tension

could mount as the players see if the *Two Brothers* can make it in time to balance the uneven contest.

Other alternatives must be explored in the same way. The object is to build events to a climactic confrontation that will be exciting and satisfying to all concerned.

ENDING THE ADVENTURE

Once the Tellarites are defeated, and their plot uncovered, the adventure (but not the campaign!) is at an end. The **Gamemaster Notes** describe some of the possible outcomes of the adventure. It shows how the scenario can lead into further possibilities for a merchant campaign.

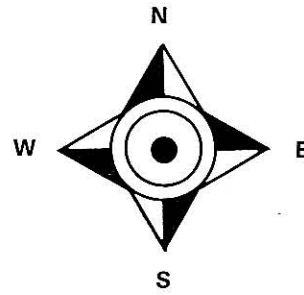

Descale Mining Camp

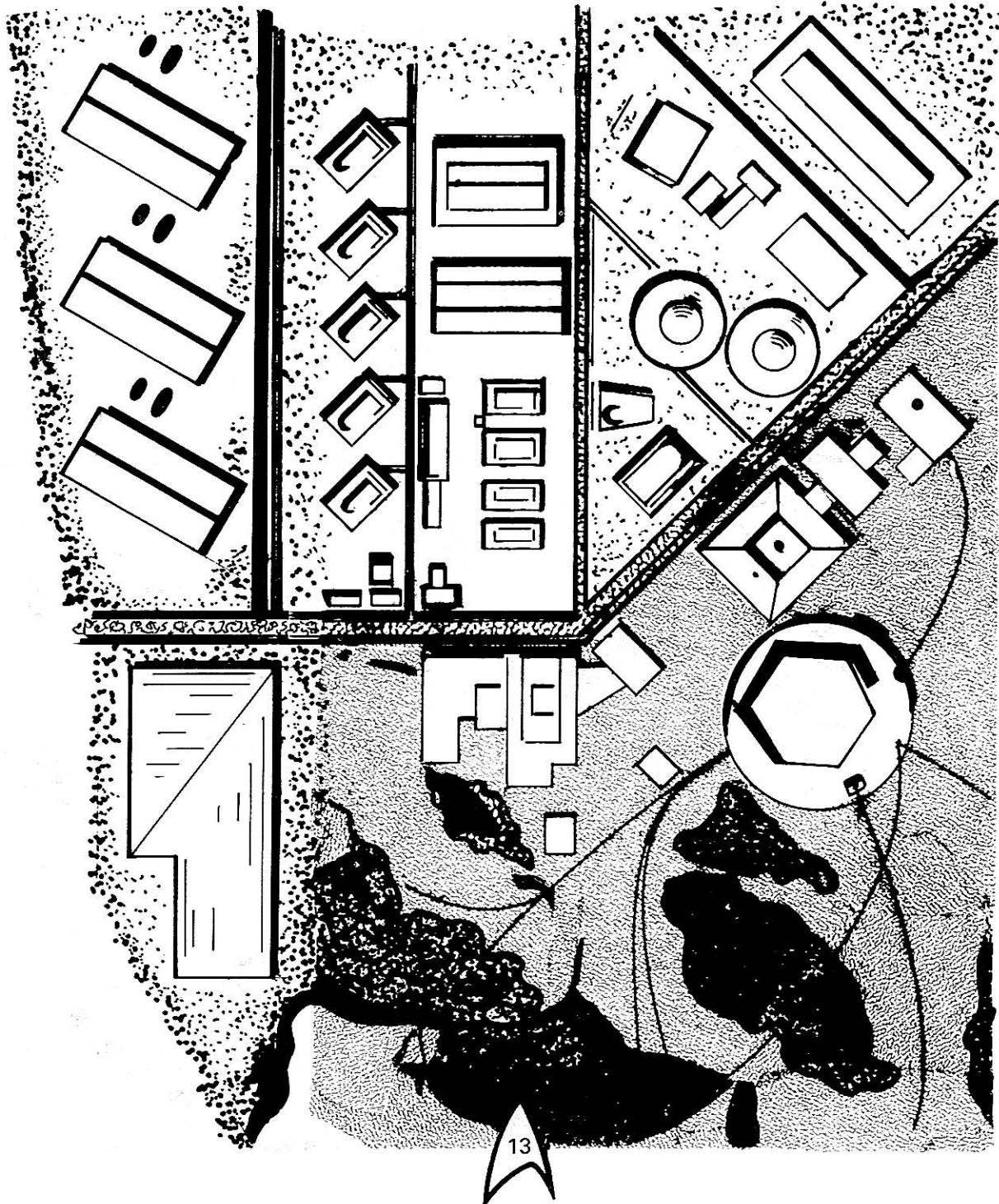

Background Information

WORLD LOG



System Name DANTHOS
 Number of Class M Present (D100 Roll) Single

D100 Roll for Number of Class M Present
 01-90 = 1 Class M World
 91 - 97 = 2 Class M Worlds
 98 - 00 = 3 Class M Worlds

World Name CORIDAN
 Position in System (D10 Roll) IV
 Number of Satellites (D10 Roll) 1
 Planetary Gravity ($\frac{10^{10} + 5}{10}$) 1.2 G

D10 Roll for Number of Satellites
 1-2 = 0 Satellites 9 = Satellites
 4-6 = 1 Satellites 10 = Satellites
 7-8 = 2 Satellites

Planetary Size:
 Diameter 15,600 km
 Equatorial Circumference 48,000 km
 Total Surface Area 522,000,000 km²
 Percent Land Mass (D100 Roll) 95 %
 Total Land Area 496,500,000 km²

Diameter = 13,000km x Planetary Gravity
 Circumference = 40,000km x Planetary Gravity
 Total Surface Area = 510,000,000 x Planetary Gravity
 Total Land Area = Total Surface Area x % Land Mass

Planetary Conditions:
 Length of Day (14 - 2010) 25 hours
 Atmospheric Density (D10 Roll) Thin

D10 Roll for Atmospheric Density
 1-2 = Thin Atmosphere
 3-8 = Terrestrial Atmosphere
 9-10 = Thick Atmosphere

General Climate (D100 Roll) Cool Temperate

D100 Roll
 01-15 = Desert Climate 61-85 = Cool Temperate Climate
 16-35 = Tropical Climate 86-00 = Arctic Climate
 36-60 = Warm Temperate Climate

Mineral Content (D100 Roll):
 Normal Metals 32% Radioactives 30% Industrial Crystals 9%, largely dilithium
 Special Metals Trace Gemstones 4%

Dominant Native Life Form: Avians
 Native Sentients: None

Technological Index/Sociopolitical Index Code: 987594-67
 Planetary Trade Profile: FCAGDEF/B(E)

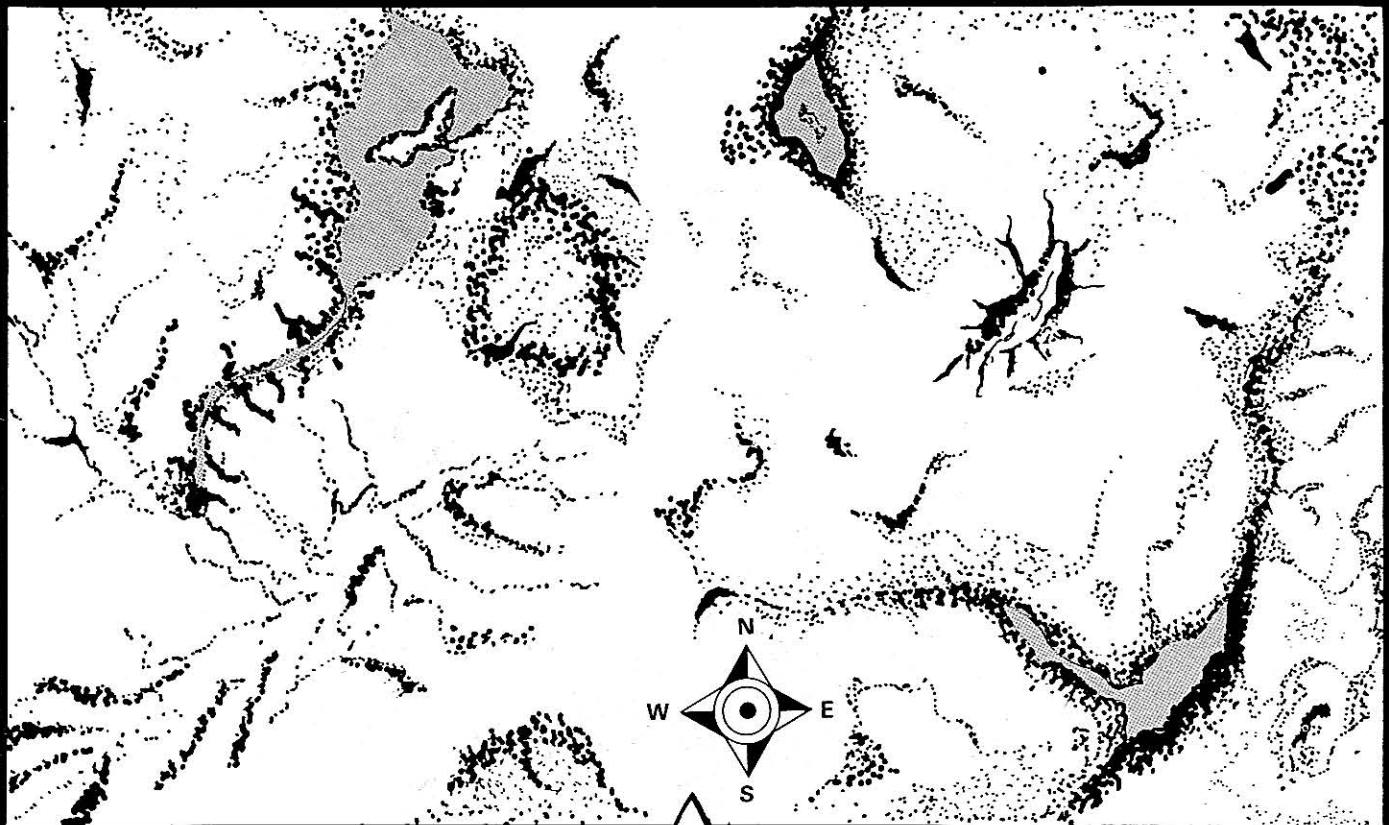

CORIDAN

Coridan, a dense world due to its heavy mineralization, is especially rich in dilithium crystals. It was settled by a mixed population of Humans and the very Human-like Alpha Centaurans more than 75 years ago (records are somewhat sparse). The colonists found conditions on Coridan harsh, and the colony never did very well, seeing little expansion; Coridan largely has been overlooked in favor of the more pleasant colony worlds available. The first city remains the only major center of population.

Mining became an important industry, of course, but because the Coridian colony was small and not fully self-sufficient in the areas of manufacturing and agriculture, the early efforts to make the mines pay off proved more difficult than anticipated. Too many colonists were needed for other jobs, and it proved to be expensive to work the mines with imported equipment and local labor.

Coridan's wealth of resources attracted attention from off-planet. As word of the situation got around, profiteers from far and wide appeared on the scene to begin exploiting Coridan for their own ends. Several groups found that it was quite profitable to import a transport vessel equipped with modern mining gear and skilled technicians. Such a ship would establish a mining base in some remote area, load up a full hold with dilithium crystals, and run for home. The situation was highly illegal; the Coridan colonists could have collected a great deal of money through mining licenses and other revenues from these off-world concerns, but their laws could not be enforced. Smugglers made enormous profits from Coridian resources, paying nothing to the colony in return, and their streamlined operations made it possible for their plundered crystals to be sold for less than legally-mined Coridian dilithium.

The major offenders in this matter were Orions, who not only made a tremendous profit from selling crystals on the open market, but are also believed to have built most of the versatile little starships of their informal navy using Coridian crystals in their power plants.

The Orions were not alone; several Federation concerns also were involved in illegal mining. Human-owned companies are known to have dabbled in the trade, but the Tellarites were the only Federation members who are believed to have engaged in dilithium raiding on an organized basis. It is thought that certain Tellarite corporations with strong government influence dictated the world's policy before Coridan applied for Federation membership.

The Coridian government applied, hoping that membership in the UFP, with its more-active protection from Star Fleet, would at least halt the illegal mining operations. This would make it possible for the Coridians to compete in the dilithium market without being undersold by the raiding operations.

The UFP did not grant immediate membership, nor has it yet. Most UFP members are flourishing, high-population worlds with the economic strength needed to contribute significantly to common Federation interests. Exceptions had been granted in the past, but the Coridian question was controversial, and so the Federation convened a special conference on Babel to debate the issue. The *USS Enterprise*, one of several vessels involved in the transport of conference delegates, became the target both of an assassin within and of an attack from another vessel. Though responsibility was disavowed by the Potentate of Orion, these actions proved to be machinations by Orions, who had hoped to start a major civil war in the Federation over the Coridian issue.

Though the Orion plan was thwarted in the "Journey to Babel" incident, the Babel conference was no less stormy because of it. The replacement for the Tellarite ambassador (who had been assassinated) was intractable and argumentative, and the proponents of Coridian admission were forced to reach a compromise.

The world was not given full membership status because it was just too poorly populated and in too bad an economic condition. It was established as a Federation Protectorate. This entitled Coridan to both Star Fleet protection and Federation developmental assistance. It was intended that Coridan be guided and assisted in stabilizing its economy, so that ultimate full membership status might one day be achieved.

A Planetary Observation Unit was established, originally 50 Star Fleet officers and enlisted personnel but later downgraded to a handful because of increasing commitments on the Klingon, Romulan, and Gorn frontiers. The POU was responsible for policing the world, keeping an eye out for raiders and smugglers, and handling liaison with the Protectorate government. At the same time, capital was poured in to Coridan to support various mining companies (the largest of which, Descale Resources and Tarsine Mining, actually are listed on the Federation Stock Exchange).

Dilithium raiding died away, thanks to the Protectorate. In its early days it was able to effectively monitor Coridan for raiders, and the raids died out as it became impossible to make them pay off on a consistent basis. Later, it became central to the development project that all resource exploitation on Coridan be locally based and owned, and that other companies wishing to do business in Coridian crystals could do so strictly through these local firms. This was a good idea, but the local firms made deals with various off-planet companies to provide them crystals at lower prices in exchange for technical advice and material assistance. This led to a general scramble among both the Coridian companies and their off-world backers to get the most solid deals possible, and competition became very fierce as a result.

Presently Tarsine Minerals is heavily backed by a relatively small firm from Alpha Centauri, TriMark Industries. Descale deals almost exclusively with Grupharg, a Tellarite trading firm widely suspected to have been at the forefront of the Tellarite dilithium raids of pre-Protectorate Coridan. Other, smaller companies have ties with a variety of other firms, but only a few are willing to deal with independents. The new scramble for competitive slices of the local market now is perceived as being far more of a matter for concern than raiding, and problems in the Protectorate continue to be a major subject for dispute among members of the Federation council.

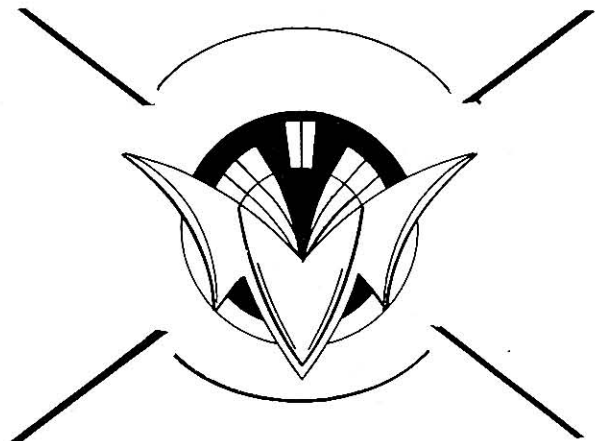

CORPORATION FILES

AKALZED ENTERPRISES

Stock Profile Code: 4A00

Akalzed Enterprises is the company owned and operated by Alemir Akalzed, the Orion trader/smuggler/slaver/pirate. Stock in his company is not traded on the Federation market, but he has been known to take partners on a private basis from time to time. Akalzed's ventures are generally highly profitable, but frequently involve illegalities. At least some of his 'stock sales' are elaborate con games designed to fleece the unwary and the greedy of large sums of cash.

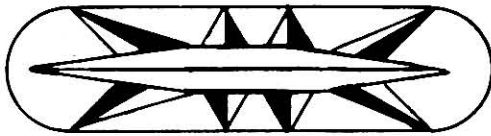
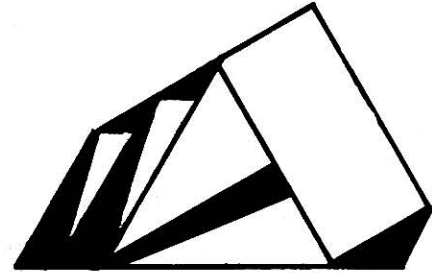

DESCALE RESOURCES, INC.

Stock Profile Code: 4D28

Though it the largest and one of the most promising new Coridian mining firms, Descale is not particularly stable. With the further development of dilithium mining operations on Coridan, however, it is expected to become a very worthwhile offering.

GRUPHARG

Stock Profile Code: 2E58

This Tellarite corporation once was a leading trading house throughout the Federation, with interests not only in shipping but also resource exploitation, ship-building, and land development on new colony worlds. The company's fortunes have fallen somewhat of late, and the firm has lost quite a bit of its hold on all these markets. Nevertheless, close ties with the government of Tellar allow Grapharg to wield considerable influence, and efforts are being made to turn around their declining economic status.

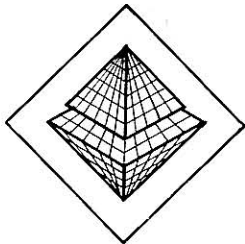
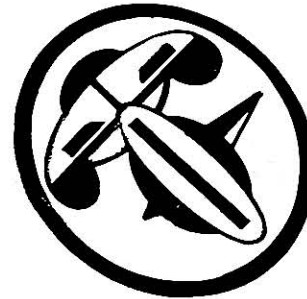

TARSINE MINERALS

Stock Profile Code: 3E41

Tarsine is the second largest mining firm on Coridan. It is seen as being slightly more stable than its larger rival, but with a somewhat smaller immediate growth potential due to its smaller capitalization.

TRIMARK INDUSTRIES

Stock Profile Code: 3C44

This corporation is primarily involved in the manufacture of starship and industrial power plants and other matter/anti-matter containment and channeling systems. It is a major subcontractor of Shuvinaaljis Warp Technologies, Inc., whose starship drive design teams plan to incorporate TriMark products into various Star Fleet vessels over the next 10 to 15 years. TriMark is still a young company with fair growth potential, but its stock tends to fluctuate considerably in value.

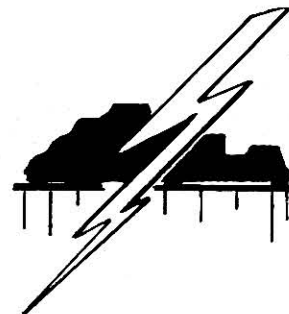

VESSELS

THE TWO BROTHERS

The *Two Brothers* is a cargo transport of the *Mission* class, originally in Star Fleet service as the transport *Edward Pellew* (NCC-61204). Following the Organian peace treaty, when general service cutbacks were being made, the transport was retired and put up for sale. It has had several owners since then, undergoing periodic modifications as it has changed hands. The most recent owners are David and James Ross (hence the name), backed by Christine Sorensson.

It should be noted that certain specific modifications exist on the *Two Brothers* that are not common to other ships of the same type. Where these are important, they are noted below.

The ship's upper deck is only 2 meters, rather than the usual 3, in height, and holds the engineering controls, computer, drive machinery, and weaponry. The full-sized middle deck holds an 8-man bunkroom, the Captain's quarters, a crew lounge, and a storage area for ship's equipment. The full-sized lowest deck contains the cargo hold, a 3-man transporter, and the bridge.

The crew is generally set at 9 people, with specific responsibilities in emergency situations. Two people could run the ship, though this would mean either heel-and-toe watches, or heavy reliance on the computer to alert the crew to dangers. Usually, though, 3 watchstanding bridge officers and at least 1 engineer are required, and other positions would be filled if possible.

Aboard *Two Brothers*, responsibilities break down as shown in the table below.

When not in an emergency situation, not all positions will be manned. In close approaches to a planet, one Engineer, a Pilot and a Navigator, and, perhaps, the Communications Officer will be required at their stations. In deep space, a single watchstander on the bridge and, most of the time (but not necessarily always), an Engineer are perfectly sufficient. Six-hour bridge watches are generally stood, and eight-hour engineering shifts. The Chief Officer, Cargo Handler, and Doctor rotate duties such as food preparation, cleaning, inventory, and administrative work between themselves as needed, and everyone generally pitches in to help everyone else as they can.

BUNKROOM

Partitions have been introduced into the bunkroom to provide 4 small double-occupancy areas for increased privacy. The partitions are lightweight and not particularly sturdy, being more in the nature of screens than anything else. Because several individuals generally are on watch at any given time, the partitioning allows a crewman a fair chance of having a cubicle to himself at any given time.

CARGO BAY

Concealed access panels in the cargo bay permit crewmen access to the area under the flight of steps up to the middle deck. This was installed by a previous owner who occasionally turned his hand at smuggling. One SCU of cargo, or up to 3 people, could be concealed in the compartment.

BRIDGE

The previous owner of the *Two Brothers* was notoriously bad about keeping the ship in repair. Routine operations are generally no problem, though the ship is often slow in responding, and warning lights flicker on and off when the power is first turned on to the impulse engines.

Crew Responsibilities Aboard The *Two Brothers*

Position	Officer	Routine Post	Emergency Post
Captain	J. Ross	Watchstander	Command
Chief Officer	C. Sorensson	Business Manager	Science
Second Officer	U'kowl	Watchstander	Helm
Third Officer	A. Orlov	Watchstander	Navigation
Communications	Sorek	Watchstander	Communications
Chief Engineer	D. Ross	Engineering Watch	Engineering
Asst. Engineer	M. Sandoval	Engineering Watch	Engineering
Cargo Handler	J. Mboya	None	Phaser
Ship's Doctor	R. Lawrence	None	Lounge

Two Brothers Commercial Transport

Hull Data:

Class — Mission Class
 Numbers — 61000 to 61399
 Model Numbers — MK II
 Date Entering Service — 1/9112
 Number Constructed — 372
 Size
 Length — 32 m
 Width — 25 m
 Height — 13 m
 Weight — 9000 mt
 Cargo Units — 150 SCU

Other Data:

Crew — 9
 Transporters —
 1 standard 3-person
 1 cargo

Engines And Power Data:

Total Power Units Available — 14
 Movement Point Ratio — 3/2
 Warp Engine Type — FWA
 Number — 2
 Power Units Available — 6
 Stress Charts — G/K
 Maximum Safe Cruising Speed — Warp 7.5
 Emergency Speed — Warp 9
 Impulse Engine Type — FIA
 Power Units Available — 2

Weapons And Firing Data:

Beam Weapon Type — FH-6
 Number — 1
 Firing Arcs — port/fwd/stbd
 Firing Chart — N
 Power Range — 0-3
 Damage Modifiers — +2(1-7) +1(8-13)

Shields And Damage Control Data:

Superstructure Points — 5 Superstructure Damage
 Chart — B
 Deflector Shield Type — FSC
 Shield Point Ratio — 1/1
 Maximum Shield Power — 8

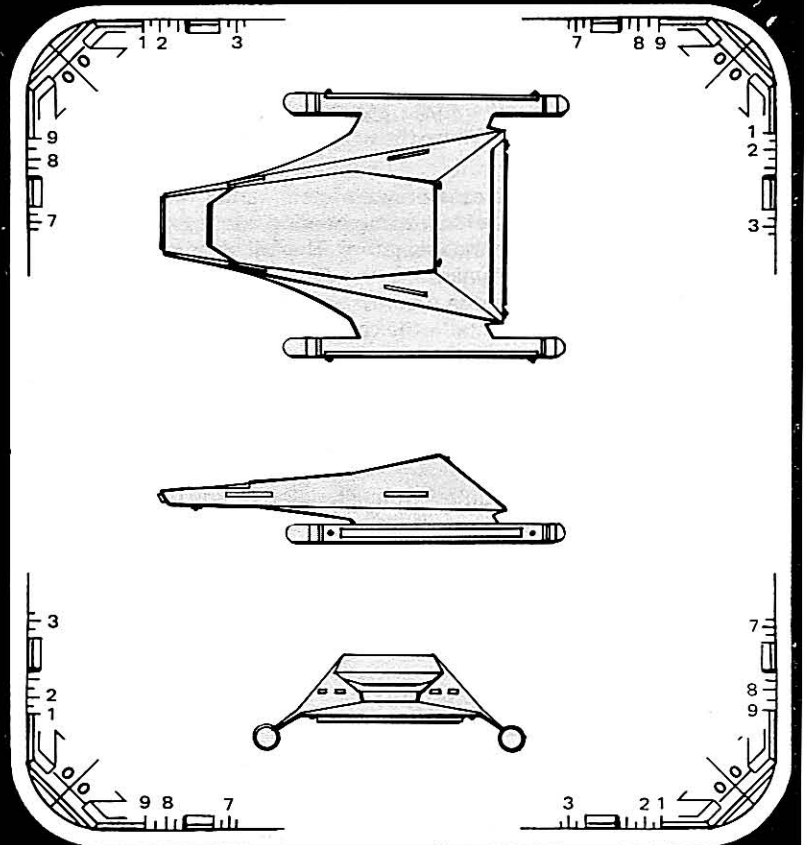

THE ROULASHAKBALLIH

Akalzed's old, battered vessel is an *Argon* Class medium commercial transport bought many years ago by a small Orion trading firm that couldn't afford anything better than surplus from the Federation merchant marine. Like all of its class, it is a sturdy, dependable freighter, designed for practicality rather than appearance. It is equipped with landing thrusters for atmospheric landings.

Under the captaincy of Alemir Akalzed, there have been a number of modifications to the basic design. As his profits have been for the most part high, Akalzed has been able to afford the addition of a number of things which make the old freighter far superior to many brand new *Argon* Class transports; the data before his alterations is given in parenthesis. He lavishes little attention, however, on external appearance. It is Akalzed's philosophy that most people underestimate old or shabby things (be they ships or buildings or people), and he prefers to be underestimated whenever and wherever possible.

As can be seen, the modifications increased the overall tonnage of the ship by adding larger warp engines. In addition, by adding lighter but more powerful impulse engines, sufficient room was gained to add in some weaponry (often very important to Akalzed's work). There was additional space left over by these modifications, which the Orion put to good use: a concealed compartment is now present housing 40 SCUs of cargo space. Both the weaponry and the new cargo space are located aft, in the area where the impulse drives are mounted. Akalzed has arranged it so the casual visitor might not realize that the compartment is anything but an engine room, and uses the concealed cargo space for smuggling purposes. The weaponry can only fire aft, not forward, but this is fine for the Orion ship, since it is usually running from pursuers anyway.

Shields also have been incorporated into the hull. The overall effect is a ship basically similar to the original *Argon* Class freighter, but with larger warp nacelles; in fact, though, *Roulashakballih* is considerably better in almost every respect than a normal merchant vessel. It is also unique; the actual value of the ship is almost impossible to calculate at current market rates.

Roulashakballih Medium Commercial Transport

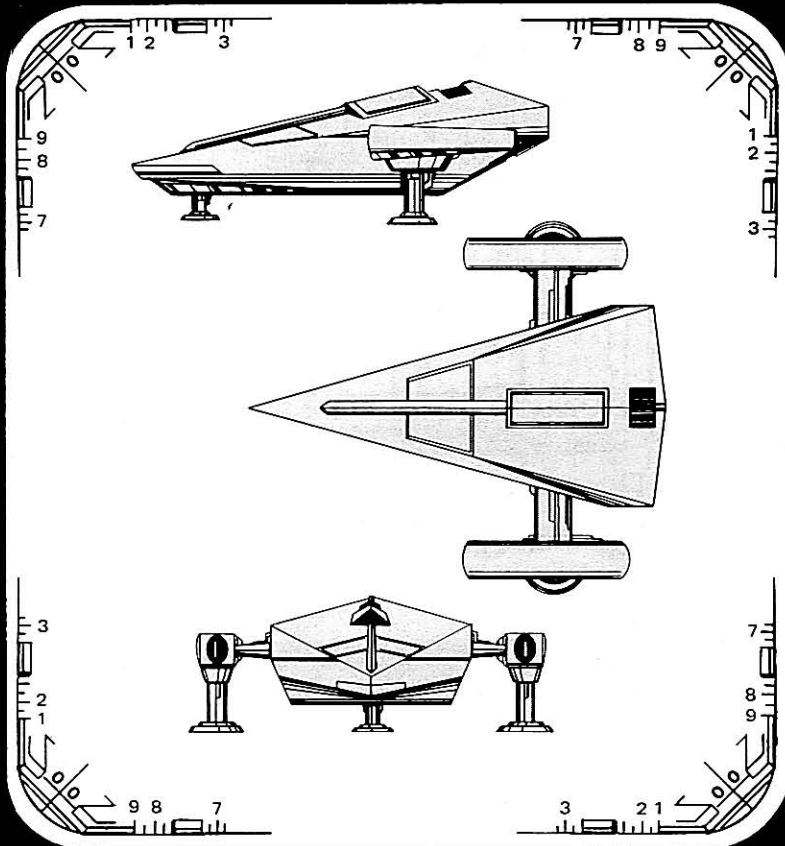

Hull Data:

Class — Argon Class
Numbers — G400000-G400399
Model Numbers — MK IV (Modified)
Date Entering Service — 1/8609
Number Constructed — 308
Size
 Length — 90 m
 Width — 106 m
 Height — 18 m
 Weight — 19,000 mt (15,000 mt)
 Cargo Units — 7200 SCU

Other Data:

Crew — 18
Transporters —
 1 standard 6-person
 1 cargo

Engines And Power Data:

Total Power Units Available — 32 (22)
Movement Point Ratio — 3/1 (2/1)
Warp Engine Type — OWA (FWH)
Number — 2
Power Units Available — 15 (10)
Stress Charts — G/F (P/Q)
Maximum Safe Cruising Speed — Warp 8 (5)
Emergency Speed — Warp 10 (6)
Impulse Engine Type — OIB (FIB)
Power Units Available — 2

Weapons And Firing Data:

Beam Weapon Type — OD-1 (None)
Number — 1
Firing Arcs — aft
Firing Chart — J
Power Range — 0-3
Damage Modifiers — +2(1-5) +1(6-10)

Shields And Damage Control Data:

Superstructure Points — 6
Superstructure Damage Chart — B
Deflector Shield Type — OSA (Navigational Only)
Shield Point Ratio — 1/1
Maximum Shield Power — 4

THE GAVIKUGH

The *Gavikugh* is a medium freighter of a standard Tellarite design, manufactured by Grupharg for their own use; other ships of the class are sold on the open market. Primarily intended for trade on and beyond the Federation frontiers, the ship is lightly armed and shielded. It is equipped for atmospheric landings. The vessel is but one of over a

hundred *Kraphija* Class freighters manufactured by Grupharg over the last decade.

As is typical of Tellarite designs, the vessel was designed for power and practicality, rather than aesthetic considerations. It is a bulky, ugly ship, maintained to an absolute peak condition. It may not please the eye with graceful lines or smooth curves, but any spacer can see that the ship has been cared for by skilled and dedicated people.

Gavikugh Medium Commercial Transport

Hull Data:

Class — *Kraphija* Class
 Numbers — G700600-G700999
 Model Numbers — MK V
 Date Entering Service — 2/0202
 Number Constructed — 112
 Size
 Length — 72 m
 Width — 146 m
 Height — 15 m
 Weight — 30,000 mt
 Cargo Units — 12,000 SCU

Other Data:

Crew — 25
 Transporters —
 2 standard 6-person
 2 cargo

Engines And Power Data:

Total Power Units Available — 13
 Movement Point Ratio — 2/1
 Warp Engine Type — FWB
 Number — 1
 Power Units Available — 9
 Stress Charts — L/M
 Maximum Safe Cruising Speed — Warp 5
 Emergency Speed — Warp 5
 Impulse Engine Type — FIC
 Power Units Available — 4

Weapons And Firing Data:

Beam Weapon Type — FH-3
 Number — 1
 Firing Arcs — port/fwd/stbd
 Firing Chart — W
 Power Range — 0-5
 Damage Modifiers — +3(1-10) +2(11-17)
 +1(18-20)

Shields And Damage Control Data:

Superstructure Points — 8
 Superstructure Damage Chart — B
 Deflector Shield Type — FSB
 Shield Point Ratio — 1/2
 Maximum Shield Power — 6

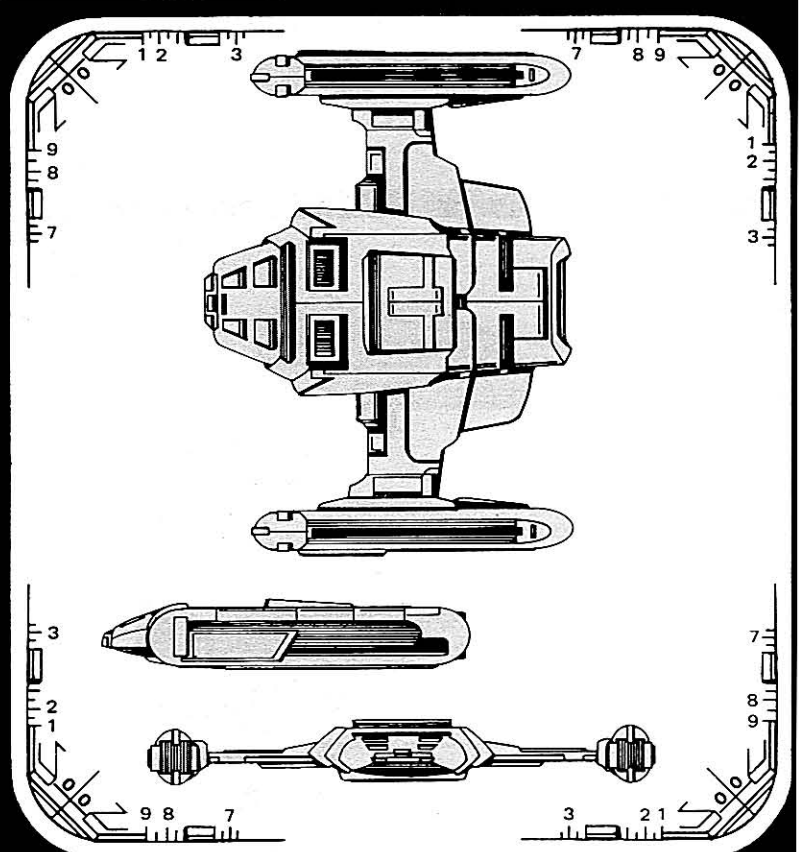

1 sq. = 1.5 meters

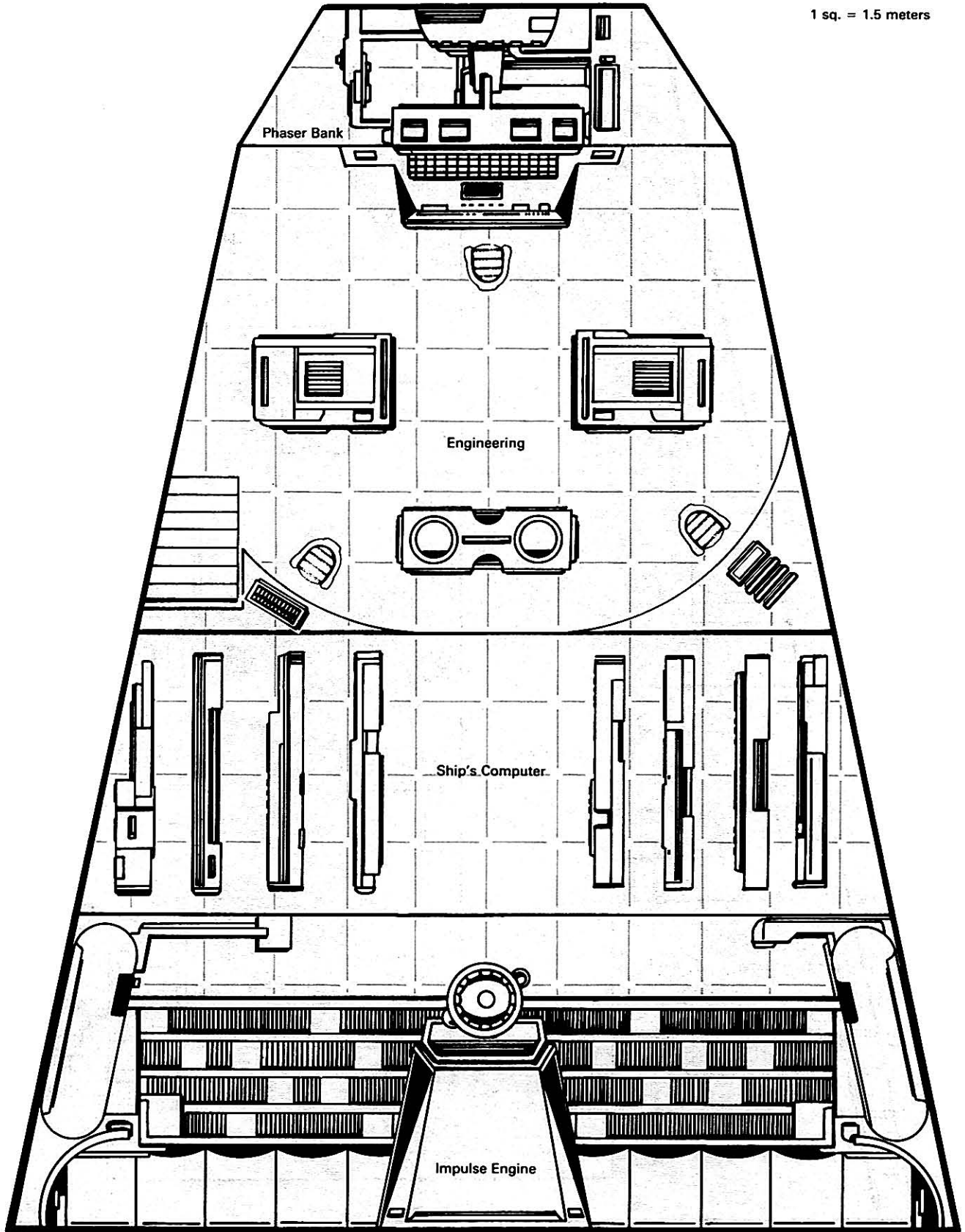

1 sq. = 1.5 meters

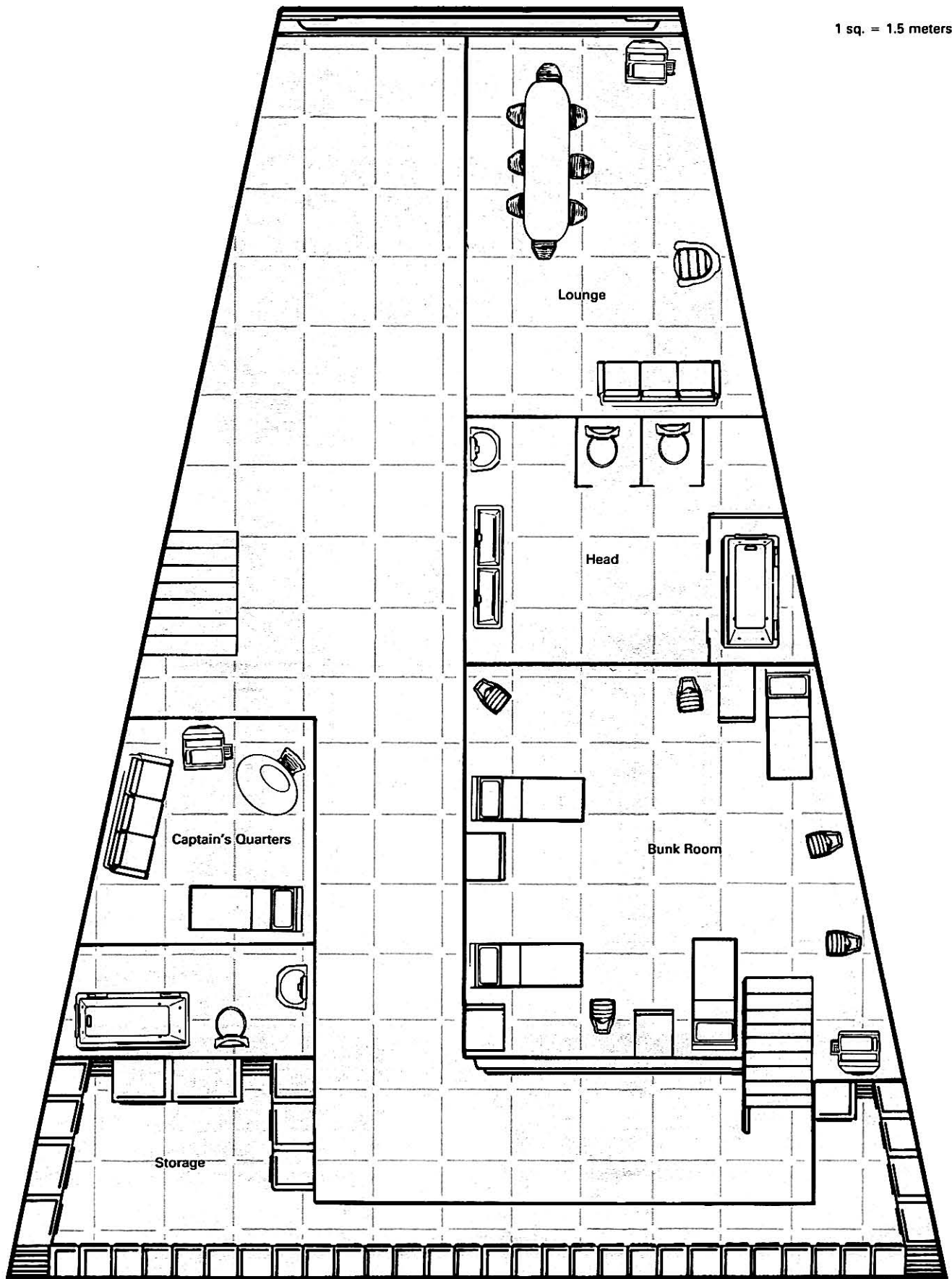

1 sq. = 1.5 meters

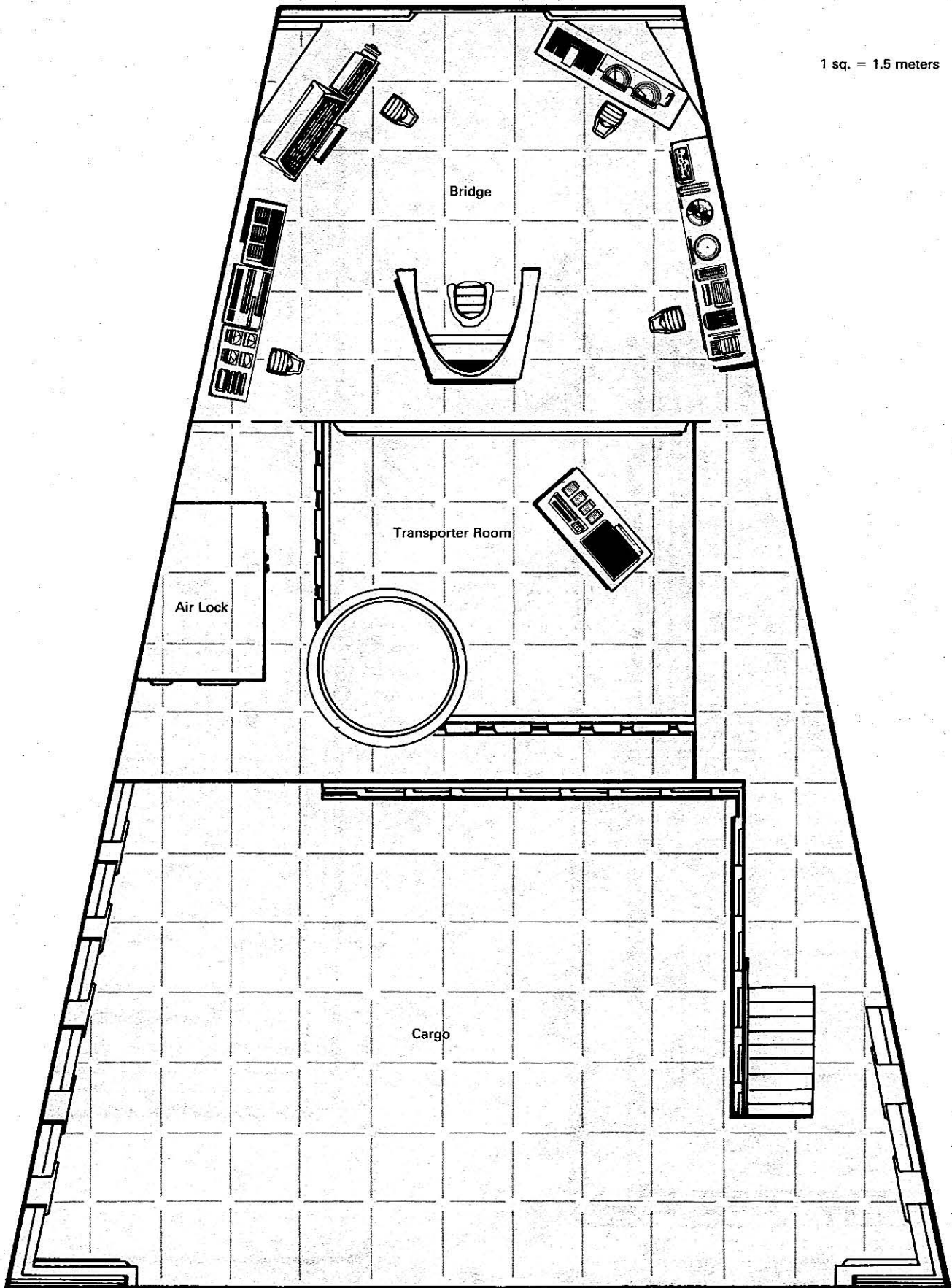

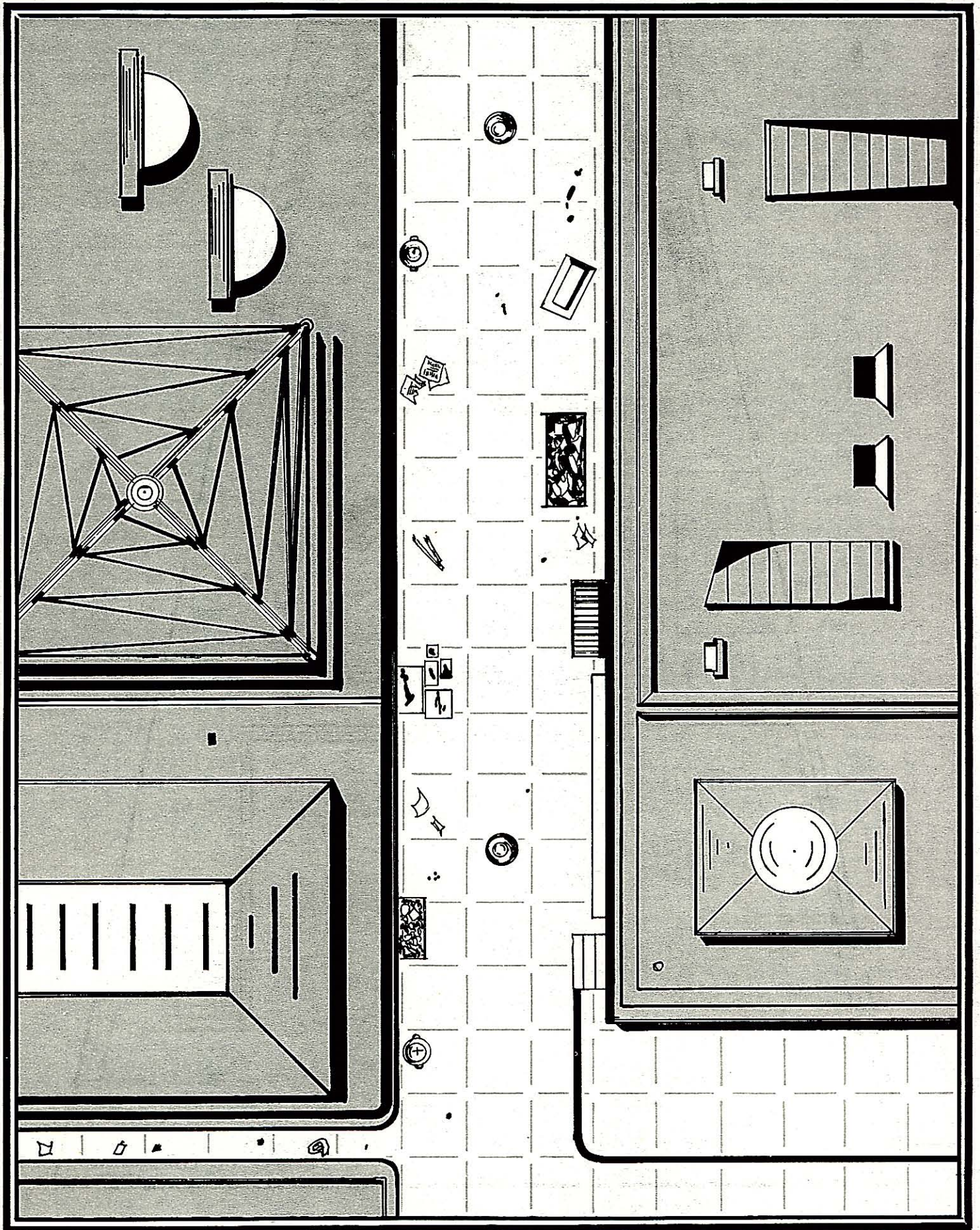

Engineering Display

Master Control Panel

Impulse Engine

Vessel Name Roulashakballih

Vessel Class Argon

Captain's Name Alemir Akalzed

Race Orion

Type <u>OIB</u>	1	2	3	4	5	6	7	8	9	10	11	12	13	14	15	16	17	18	19	20	21	22	23
-----------------	---	---	---	---	---	---	---	---	---	----	----	----	----	----	----	----	----	----	----	----	----	----	----

Warp Engine #1

Type <u>OWA</u>	1	2	3	4	5	6	7	8	9	10	11	12	13	14	15	16	17	18	19	20	21	22	23	24	25	26
-----------------	---	---	---	---	---	---	---	---	---	----	----	----	----	----	----	----	----	----	----	----	----	----	----	----	----	----

Warp Engine #2

Type <u>OWA</u>	1	2	3	4	5	6	7	8	9	10	11	12	13	14	15	16	17	18	19	20	21	22	23	24	25	26
-----------------	---	---	---	---	---	---	---	---	---	----	----	----	----	----	----	----	----	----	----	----	----	----	----	----	----	----

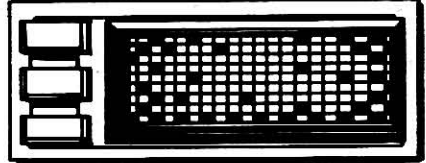

Turn #	1	2	3	4	5	6	7	8	9	10	11	12	13	14	15	16	17	18	19
Total Power Units Available	32																		
Power to Movement																			
Movement Point Ratio <u>3/1</u>																			
Power to Shields																			
Shield Point Ratio <u>1/1</u>																			
Power to Weapons																			

Helm Display



Movement Points																			
Current Warp Speed																			

Weapons Display



Beam Type	Type	Firing Chart	Power Range	Beam Type	Type	Firing Chart	Power Range	Beam Type	Type	Firing Chart	Power Range	Beam Type	Type	Firing Chart	Power Range	Beam Type	Type	Firing Chart	Power Range	Beam Type	Type	Firing Chart	Power Range	
OD-1	J	0-3	3	1-5	1	6-10																		
OD-1	F	(A)																						
	F	P S																						
	F	P S																						
	F	P S																						
	F	P S																						
	F	P S																						
	F	P S																						
	F	P S																						
	F	P S																						
	F	P S																						
	F	P S																						
	F	P S																						
	F	P S																						
	F	P S																						
	F	P S																						
	F	P S																						
	F	P S																						
	F	P S																						
	F	P S																						
	F	P S																						
	F	P S																						
	F	P S																						
	F	P S																						

Damage Control Display

Shield Type OSA

Shield Point Ratio 1 / 1

Maximum Shield Power 4

Shield Points Available

Turn #	1	2	3	4	5	6	7	8	9	10	11	12	13	14	15	16	17	18	19	

1

D	0	1	2	3	4	5	6
1							
2							
3							
4							
5							
6							
7							
8							
9							
10							
11							
12							
13							
14							
15							
16							

20

D	0	1	2	3	4	5	6
1							
2							
3							
4							
5							
6							
7							
8							
9							
10							
11							
12							
13							
14							
15							
16							

Damage Chart B Stress Chart: Engine G Superstructure F

Superstructure

1	2	3	4	5	6	7	8	9	10	11	12	13	14	15	16	17	18	19	20
21	22	23	24	25	26	27	28	29	30	31	32	33	34	35	36	37	38	39	40
41	42	43	44	45	46	47	48	49	50										

Die Roll Modifier Table

Crew	18	90%	80%	70%	60%	50%	40%	30%	20%	10%
		+9	+8	+7	+6	+5	+4	+3	+2	+1

% of Casualties

Turn #	1	2	3	4	5	6	7	8	9	10	11	12	13	14	15	16	17	18	19	

Sensors

Turn #	1	2	3	4	5	6	7	8	9	10	11	12	13	14	15	16	17	18	19	
	L	L	L	L	L	L	L	L	L	L	L	L	L	L	L	L	L	L	L	L
	O	O	O	O	O	O	O	O	O	O	O	O	O	O	O	O	O	O	O	O

Engineering Display

Master Control Panel

Impulse Engine

Vessel Name Gavikugh

Vessel Class Kraphija

Captain's Name _____

Race Tellarite

Type FIC [1 2 3 4 5 6 7 8 9 10 11 12 13 14 15 16 17 18 19 20 21 22 23]

Warp Engine #1

Type FWB [1 2 3 4 5 6 7 8 9 10 11 12 13 14 15 16 17 18 19 20 21 22 23 24 25 26]

Warp Engine #2

Type _____ [1 2 3 4 5 6 7 8 9 10 11 12 13 14 15 16 17 18 19 20 21 22 23 24 25 26]

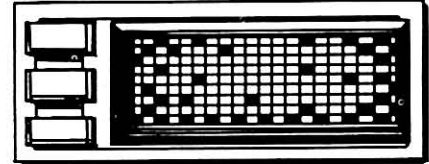

Turn # 1 2 3 4 5 6 7 8 9 10 11 12 13 14 15 16 17 18 19

Total Power Units Available	13																					
Power to Movement Movement Point Ratio <u>2/1</u>																						
Power to Shields Shield Point Ratio <u>1/2</u>																						
Power to Weapons																						

Helm Display

Movement Points																						
Current Warp Speed																						

Weapons Display

Beam Type <u>FH-3</u> Firing Chart <u>W</u> Power Range <u>0-5</u> + 3(1-10) + 2(11-17) + 1(18-20)	Beam Type _____ Firing Chart _____ Power Range _____ + 3(. .) + 2(. .) + 1(. .)	Beam Type _____ Firing Chart _____ Power Range _____ + 3(. .) + 2(. .) + 1(. .)
Beam Type _____ Firing Chart _____ Power Range _____ + 3(. .) + 2(. .) + 1(. .)	Beam Type _____ Firing Chart _____ Power Range _____ + 3(. .) + 2(. .) + 1(. .)	Missile Type _____ Firing Chart _____ Power to Arm _____ Damage _____

Type <u>FH-3</u> Firing Arc <u>PSA</u>																						
Type _____ Firing Arc <u>PSA</u>																						
Type _____ Firing Arc <u>PSA</u>																						
Type _____ Firing Arc <u>PSA</u>																						
Type _____ Firing Arc <u>PSA</u>																						
Type _____ Firing Arc <u>PSA</u>																						
Type _____ Firing Arc <u>PSA</u>																						
Type _____ Firing Arc <u>PSA</u>																						
Type _____ Firing Arc <u>PSA</u>																						
Type _____ Firing Arc <u>PSA</u>																						
Type _____ Firing Arc <u>PSA</u>																						
Type _____ Firing Arc <u>PSA</u>																						
Type _____ Firing Arc <u>PSA</u>																						
Type _____ Firing Arc <u>PSA</u>																						
Type _____ Firing Arc <u>PSA</u>																						
Type _____ Firing Arc <u>PSA</u>																						

Damage Control Display

Shield Type FSB

Shield Point Ratio 1 / 2

Maximum Shield Power 6

Shield Points Available

Turn #	1	2	3	4	5	6	7	8	9	10	11	12	13	14	15	16	17	18	19	

1

D	0	1	2	3	4	5	6
0							
1							
2							
3							
4							
5							
6							
7							
8							
9							
10							
11							
12							
13							
14							
15							
16							

19

D	0	1	2	3	4	5	6
0							
1							
2							
3							
4							
5							
6							
7							
8							
9							
10							
11							
12							
13							
14							
15							
16							

Damage Chart B Stress Chart: Engine L Superstructure M

Superstructure

1	2	3	4	5	6	7	8	9	10	11	12	13	14	15	16	17	18	19	20
21	22	23	24	25	26	27	28	29	30	31	32	33	34	35	36	37	38	39	40
41	42	43	44	45	46	47	48	49	50										

Crew 25

90°	80°	70°	60°	50°	40°	30°	20°	10°
+9	+8	+7	+6	+5	+4	+3	+2	+1

	% of Casualties																			
	Turn #	1	2	3	4	5	6	7	8	9	10	11	12	13	14	15	16	17	18	19
	Sensors																			
	Turn #	1	2	3	4	5	6	7	8	9	10	11	12	13	14	15	16	17	18	19
	L	L	L	L	L	L	L	L	L	L	L	L	L	L	L	L	L	L	L	L
	O	O	O	O	O	O	O	O	O	O	O	O	O	O	O	O	O	O	O	O

28 - Permission granted to photocopy this page for personal use only.

Cast Of Characters

CREW OF THE TWO BROTHERS

Nine characters have been provided in sufficient detail to be used as player characters. Players may use these characters as given, or they may replace any with a player character of their own. The positions of Captain, Chief Officer, and Chief Engineer should be filled by player characters; in theory, these 3 could operate the ship, though not effectively.

Additional positions may be filled by other player characters or by the characters given below as an NPC controlled by the gamemaster. Some of these characters could be eliminated entirely; the positions most easily dropped are Cargo Officer, Junior Engineer, and Third Officer, in that order.

Name: ROSS, James

Rank: Captain

Current Assignment: *Mission Class Commercial Transport Two Brothers, Federation registry*

Position: Master

Race: Human **Age:** 32

Birthplace: Terra/Scotland **Sex:** Male

Attributes

STR — 54 CHA — 82
 END — 59 LUC — 71
 INT — 76 PSI — 46
 DEX — 54

To-Hit; Modern: 41 **Bare-Hand Damage:** 1D10+5
HTH: 40 **AP:** 9

Significant Skills	Rating
Administration	20
Carousing	14
Communication Systems Operation	10
Computer Operation	47
Computer Technology	10
Deflector Shield Operation	20
Deflector Shield Technology	10
Gaming, Chess (2-D)	15
Instruction	10
Language, Vulcan	14
Marksmanship, Modern Weapon	29
Medical Sciences	
General Medicine, Human	20
Psychology, Human	10
Negotiation/Diplomacy	17
Personal Combat, Unarmed	27
Planetary Survival, Tropics	14
Shuttlecraft Pilot	10
Small Vessel Piloting	56
Social Sciences, Fed. Law	20
Space Sciences	
Astrogation	42
Astronomy	32
Astrophysics	34
Starship Helm Operation	20
Starship Sensors	10
Streetwise	5
Trade and Commerce	20
Trivia, Scottish History	13
Value Estimation	10
Warp Drive Technology	10

Distinguishing Physical Characteristics:

James Ross is slender, fair, and very handsome — the sort of man who has a very commanding presence.

Brief Personal History:

Ross attended a merchant academy run by Federation Spaceways, Ltd., a large passenger line serving the core worlds of the Federation. On graduation, he worked his way up to the rank of Second Officer, specializing in navigation before being forced to resign during a shake-up of line organization. He held several brief jobs as a small vessel pilot with small, one-ship operations. Eventually he, his brother David, and Christine Sorensson teamed up as partners in the *Two Brothers* venture, establishing a line of their own.

Personality:

Motivations/Desires/Goals:

Ross hates working for other people; he has always wanted the chance to be on his own. Now that he has achieved that goal, however, he has lingering doubts about his abilities to follow through. He will work doubly hard to ensure the success of any venture he finds himself involved in.

His brother is very important to him, and Ross would sacrifice anything for his brother's well-being. Christine Sorensson is both his business partner and his friend, and there is a sort of unspoken, suppressed romantic involvement between the two of them.

Manner:

Ross is an easy-going, quiet-spoken individual. He leads by example, and gives orders only when necessary. Off the bridge, he likes chess, an occasional bottle of scotch, and a good book.

Special Knowledge/Powers:

None.

Money:

72,000 CR

Name: SORENSON, Christine

Rank: First Officer

Current Assignment: *Mission Class Commercial Transport
Two Brothers, Federation registry*

Position: Chief Officer

Race: Human

Age: 28

Birthplace: Terra/ United States Of Europe

Sex: Female

Attributes

STR —52 CHA —71
END —49 LUC —91
INT —83 PSI —01
DEX —70

To-Hit; Modern: 45 **Bare-Hand Damage:** 1D10+5
HTH: 45 **AP:** 11

Significant Skills

	Rating
Administration	40
Artistic Expression, Singing	15
Bribery	32
Carousing	6
Communication Systems Operation	10
Computer Operation	23
Forgery	13
Instruction	20
Language, Caitian	10
French	10
Tellarite	10
Vulcan	10
Leadership	10
Marksmanship, Modern Weapon	21
Negotiation/Diplomacy	68
Personal Combat, Unarmed	21
Medical Sciences	
Psychology, Human	20
Small Vessel Piloting	10
Social Sciences	
Federation History	10
Federation Law	36
Starship Sensors	30
Streetwise	20
Trade and Commerce	39
Value Estimation	42

Distinguishing Physical Characteristics:

Christine Sorensson is very much the typical Nordic blonde, tall, lithe, and graceful. Her hair is worn rather long, which has caused some jokes about the impracticality of mixing ship controls, zero-G conditions, and Danish blondes. Christine is left-handed.

Brief Personal History:

Born in the United States of Europe, Christine is the daughter of a wealthy business owner, Gunnar Sorensson, who owned an electronics manufacturing firm. Never very interested in the business, she went into space instead, serving in a variety of small merchant companies as a Purser and business manager. When her father died, leaving her a large inheritance, Christine offered to join partnership with the Ross brothers in a private shipping firm.

Personality:

Motivations/Desires/Goals:

Wanderlust is the key to Christine's personality. She is forever enchanted by the surfaces of new worlds, the vista of deep space, and the challenge of meeting new people. Her older brother was always groomed to take charge of the family business, and that suited Christine fine; she could imagine nothing more boring than a day-to-day routine in an unchanging office, and she is not fond of electronics anyway.

Christine is very fond of both the Ross brothers, and is doing her best to keep from becoming romantically involved with James. Her argument to herself has always been that marriage, even to another footloose wanderer like herself, would cramp her style too much.

Manner:

The Chief Officer is outgoing and magnetic, a talkative woman with a shrewd ability to learn more than she gives away while seeming to dominate the conversation. She makes frequent disparaging remarks about machinery more complicated than a hand calculator, but this is mostly an image that she likes to project: she can handle a computer with confidence and has earned her Small Vessel Pilot's Certificate of Competency to qualify her for the post she holds on the ship.

Sorensson is also an extremely gifted amateur singer, and has been known to sing everything from old Danish ballads to rough drinking songs from Tellar. She has expressed considerable reluctance, however, at the thought of learning Scottish ballads with accompaniment by David Ross on the bagpipe, which she describes as sounding "like a cat being tortured."

Special Knowledge/Powers:

A brief period of employment by a largely Tellarite shipping line has given Christine a slight grounding in both the customs and the language of the Tellarites, which might be of use in the course of the adventure.

Money:

250,000 CR

Name: ROSS, David

Rank: First Officer

Current Assignment: *Mission Class Commercial Transport
Two Brothers, Federation registry*

Position: Chief Engineer

Race: Human

Age: 30

Birthplace: Terra/Scotland

Sex: Male

Attributes

STR — 68 CHA — 60
END — 67 LUC — 37
INT — 73 PSI — 25
DEX — 73

To-Hit; Modern: 50 **Bare-Hand Damage:** 1D10+3
HTH: 36 **AP:** 11

Significant Skills

	Rating
Administration	20
Artistic Expression, Bagpipes	14
Carousing	30
Communication Systems Operation	10
Computer Operation	21
Computer Technology	29
Deflector Shield Operation	30
Deflector Shield Technology	10
Electronics Technology	33
Environmental Suit Operation	10
Instruction	10
Life Support Systems Technology	10
Marksmanship, Modern Weapon	27
Mechanical Engineering	20
Medical Sciences	
Psychology, Human	10
Negotiation Diplomacy	10
Physical Sciences, Physics	10
Small Equipment Systems Operation	20
Small Equipment Systems Technology	9
Small Vessel Engineering	52
Small Vessel Piloting	10
Social Sciences, Federation Law	20
Space Sciences, Astronautics	44
Starship Sensors	10
Trade and Commerce	20
Transporter Operation Procedures	18
Transporter Systems Technology	17
Trivia, Distillation	9
Value Estimation	10
Warp Drive Technology	10

Distinguishing Physical Characteristics:

David Ross is almost the opposite of his brother. He is shorter, stockier, and has dark hair and a dark complexion. Less handsome than James, he also is somewhat sloppy in dress and personal appearance.

Brief Personal History:

A born mechanic, David Ross built his first makeshift circuit panel at the age of 12, and has been working with his hands ever since. He followed his older brother into the Merchant Academy, and, like James, served Federation Spaceways for some time; indeed, he weathered the storm that caused his brother to resign. Shortly afterwards, however, he left Spaceways voluntarily in protest over his brother's treatment. Since then he and James have stayed together, serving in the same ships when possible.

Personality:

Motivations/Desires/Goals:

The younger Ross has something of a hero complex regarding his brother, and would follow him anywhere. He is also fond of a good time, and enjoys any sort of work involving his hands.

Manner:

The Chief Engineer is more intense than his brother, and tends to get passionately involved in just about any issue. He likes to make his Scottish origins plain to all around him: he plays the bagpipe, brews a drink he claims is Scotch in a makeshift still, and talks in a thick Scottish burr that most of his shipmates claim he studies in his off hours, just to make himself completely incomprehensible to the others. (Christine Sorensson claims he's only understandable during an emergency, when he forgets to use his accent.)

Special Knowledge/Powers:

None.

Money:

50,000 CR

Name: U'KOWL

Rank: Second Officer

Current Assignment: *Mission Class Commercial Transport
Two Brothers, Federation registry*

Position: Pilot

Race: Caitian

Age: 36

Birthplace: Kairait'korr, Kairai Colony

Sex: Male

Attributes

STR — 59 CHA — 74
END — 54 LUC — 31
INT — 81 PSI — 17
DEX — 81

To-Hit; Modern: 59 **Bare-Hand Damage:** 1D10 + 6
HTH: 59 **AP:** 12

Significant Skills

	Rating
Bribery	10
Carousing	39
Computer Operation	13
Gaming, 3-D Chess	48
Language, Galacta	34
Marksmanship	38
Negotiation/Diplomacy	10
Personal Combat, Unarmed	38
Small Vessel Engineering	10
Small Vessel Piloting	67
Social Sciences, Federation Law	22
Space Sciences, Astronomy	14
Streetwise	44
Trade and Commerce	10
Value Estimation	25
Vehicle Operation, Atmos. Craft	10

Distinguishing Physical Characteristics:

U'Kowl is a typical Caitian male, sleek, graceful, and furred. Like many of his race, he is ambidextrous.

Brief Personal History:

Going to space right out of school, U'kowl began as a steward's mate responsible for the care and feeding of pets aboard a large merchant liner. He had a natural talent for piloting, however, and eventually received the opportunity to try out as a watchstander on a smaller ship. After earning officer's papers, U'kowl moved to a life as an independent ship crewman, moving from berth to berth as needed, and eventually rising to Second Officer status.

Personality:

Motivations/Desires/Goals:

The Caitian officer obtained his current position by a circuitous route and, though proud of his achievement, is also afraid that he might make a mistake and undo all he has accomplished in his life. This makes him hesitant when making crucial decisions on his own.

Manner:

When not himself responsible for important decisions, U'kowl can be brash and outspoken. He is justifiably proud of making it to his current status, and frequently illustrates his views with references to "when I was handling cargo on the old liner. . ." and similar comments.

Special Knowledge/Powers:

None

Money:

31,500 CR

Name: LAWRENCE, Robert, M.D.

Current Assignment: *Mission Class Commercial Transport
Two Brothers, Federation registry*

Position: Ship's Doctor

Race: Human

Age: 49

Birthplace: Terra/United States Of America

Sex: Male

Attributes

STR — 44 CHA — 54
END — 53 LUC — 51
INT — 90 PSI — 01
DEX — 72

To-Hit; Modern: 50 **Bare-Hand Damage:** 1D10
HTH: 36 **AP:** 11

Significant Skills	Rating
Administration	18
Bribery	10
Carousing	56
Computer Operation	10
Gaming, Strategic Boardgames	34
Instruction	15
Marksmanship, Modern Weapon	28
Medical Sciences	
General Medicine, Human	70
Caitian	35
Vulcan	35
Psychology, Human	40
Negotiation/Diplomacy	31
Small Vessel Engineering	10
Small Vessel Piloting	10
Social Sciences, Federation Law	19
Streetwise	38
Trade and Commerce	10
Value Estimation	35

Distinguishing Physical Characteristics:

Dr. Lawrence is overweight, with a chubby face and startlingly blue eyes. His hair is, to his outspoken concern, thinning, but he looks younger than his 49 years despite this.

Brief Personal History:

The doctor has been in space for a long time. He joined a merchant line right out of medical school, but soon found he didn't like the structured life or the boredom of looking after patients whose major concerns always seemed to be hangovers or motion sickness. He found independent traders more to his liking, for if his professional life was no more interesting, his personal life got quite a boost. He enjoys travel, and has found the tramp life ideal to his purposes. Having met Christine Sorensson on a ship they served on together, the doctor hastened to look her up on hearing of the *Two Brothers* venture, and signed aboard.

Personality:

Motivations/Desires/Goals:

Lawrence wants nothing more than a chance to stretch his mind. He is an avid reader, and enjoys turning his hand at new things. The doctor is a confirmed bachelor, but does enjoy having a good time on shore leave. His love of travel keeps him in space, despite his frequently expressed need for rest and relaxation.

Manner:

Dr. Lawrence deliberately cultivates an air of laziness; he never has been known to run when walking would do, and his favorite places are his bunk and an easy chair in the lounge. He is also well-known as a complainer. Anything and everything, from his advancing age to the lack of worthwhile work for a man of his talents to almost anything else fall prey to his steady stream of sour comments. In fact, though, he is all talk, and no one takes his complaints seriously.

Special Knowledge/Powers:

None

Money: 32,000 CR

Name: SOREK

Rank: Second Officer

Current Assignment: *Mission Class Commercial Transport, Two Brothers*, Federation registry

Position: Communications Officer

Race: Vulcan

Age: 32

Birthplace: Vulcan/Shilankh Province

Sex: Male

Attributes

STR — 83 CHA — 64
END — 70 LUC — 59
INT — 81 PSI — 98
DEX — 70

To-Hit; Modern: 43 **Bare-Hand Damage:** 2D10+2
HTH: 45 **AP:** 11

Significant Skills

	Rating
Administration	20
Artistic Expression, Vulcan Lyre	15
Communication Systems Operation	20
Computer Operation	25
Computer Technology	20
Deflector Shield Operation	24
Deflector Shield Technology	10
Electronics Technology	13
Instruction	10
Language, Caitian	20
Galacta	57
Marksmanship, Modern Weapon	16
Negotiation/Diplomacy	19
Personal Combat, Unarmed	20
Shuttlecraft Pilot	10
Small Vessel Piloting	30
Social Sciences	
Federation History	14
Federation Law	20
Space Sciences	
Astrogation	20
Astronomy	20
Astrophysics	20
Starship Helm Operation	20
Starship Sensors	10
Trade and Commerce	20
Value Estimation	10
Warp Drive Technology	10

Distinguishing Physical Characteristics:

Sorek's build is fairly ordinary for a Vulcan; he is chiefly noticeable for his pronounced limp, which dates back to a wound suffered in a hijacking attempt against his ship.

Brief Personal History:

Originally part of a family-owned Vulcan trading company, Sorek was the only survivor when his ship (and with it most of his family) was the object of a hijacking. A Federation ship foiled the attempt, but not before the hijackers killed all aboard, except for Sorek. The Vulcan has a reputation for unheard-of luck among his kind as a result.

Since the incident, Sorek has been unwilling to return to Vulcan, and continues to ply the space lanes. Having signed aboard the *Two Brothers* only recently, he is the new-comer of the crew.

Personality:

Motivations/Desires/Goals:

Like all Vulcans, Sorek suppresses his emotions rigidly. In Sorek's case, there are quite a few to suppress. Inwardly, Sorek blames himself for the loss of his family. He secretly fears that he might bring bad fortune to his new shipmates as he did to his family, and compensates for his turmoil by being more actively Vulcan than many of his kind under similar conditions.

Manner:

The Vulcan is efficient and highly competent, but stays aloof from those around him. He rarely speaks outside the line of duty, and certainly has no inclination to engage in shipboard banter. To relax, he sometimes plays his lyre, and has been studying the doctrines and disciplines of Kohlinar in the hopes of putting an end to his inner turmoil once and for all.

Special Knowledge/Powers:

Sorek is a master of all Vulcan psionic techniques and in the Vulcan nerve pinch.

Money: 24,000 CR

Name: SANDOVAL, Maria

Current Assignment: *Mission Class Commercial Transport
Two Brothers, Federation registry*

Position: Engineer's Mate

Race: Human

Age: 28

Birthplace: Terra/United States Of Europe

Sex: Female

Attributes

STR — 62 CHA — 67
END — 58 LUC — 34
INT — 83 PSI — 01
DEX — 69

To-Hit; Modern: 62 **Bare-Hand Damage:** 1D10+8
HTH: 61 **AP:** 10

Significant Skills	Rating
Administration	10
Bribery	7
Carousing	55
Computer Operation	33
Computer Technology	34
Deflector Shield Operation	10
Deflector Shield Technology	10
Electronics Technology	34
Environmental Suit Operation	10
Language, Vulcan	10
Life Support Systems Technology	20
Marksmanship, Modern Weapon	55
Mechanical Engineering	20
Personal Combat, Unarmed	54
Personal Weapons Technology	10
Physical Sciences, Physics	23
Space Sciences	
Astronautics	40
Astronomy	10
Astrophysics	10
Starship Sensors	10
Starship Weaponry Technology	10
Streetwise	44
Trade and Commerce	15
Transporter Systems Operation	20
Transporter Systems Technology	10
Value Estimation	15
Vehicle Operation, Ground Craft	15
Warp Drive Technology	30

Distinguishing Physical Characteristics:

Maria Sandoval is small and dark, with short black hair and dark eyes.

Brief Personal History:

Maria completed courses at Star Fleet Academy specializing in engineering. However, she had a reputation for lack of discipline and wild behavior, and her accumulated demerits as a Cadet led to a barely passing grade. Her Cadet Cruise was a disaster; the Chief Engineer of the *USS Rommel* was a Vulcan, and, alerted to her record, he subjected her to rigid scrutiny. Her failure was so complete that Maria resigned rather than attempt a second Cadet Cruise. She has spent the years since then hopping from ship to ship, looking for a chance to advance herself as a merchant spacer.

Personality:

Motivations/Desires/Goals:

Sandoval carries an outsized chip on her shoulder. She attributes her lack of success in Star Fleet and in the merchant service (where, despite her training, she has found it difficult to get a berth commensurate with her skills) to the failures of those around her to recognize her worth, rather than to her own bad attitude. Sandoval has two particular pet peeves — Star Fleet and Vulcans.

Manner:

Maria is opinionated, stubborn, argumentative, and prone to act on her own even against direct orders to the contrary. For the most part, though, she gets along with her shipmates, except for Sorek and for David Ross, whom she believes — and sometimes openly maintains — is less qualified than she is as an Engineer.

She is uncomfortable around Sorek, and does her best to offset this by being deliberately rude to the Vulcan. This is not so much a sign of hatred as it is a mild prejudice, as she is convinced it was her Vulcan superior on the *Rommel* who caused her to lose all hope of making it in Star Fleet.

Ashore, Maria enjoys night life of all kinds, and is adept at locating dives and other unsavory entertainment spots.

Special Knowledge/Powers:

Of all the crew, Maria is most familiar with Star Fleet procedures.

Money:

8000 CR

Name: ORLOV, Alexi

Rank: Third Officer

Current Assignment: *Mission Class Commercial Transport
Two Brothers, Federation registry*

Position: Navigator

Race: Human

Age: 24

Birthplace: Terra/Russia

Sex: Male

Attributes

STR — 60	CHA — 68
END — 62	LUC — 90
INT — 83	PSI — 28
DEX — 75	

To-Hit; Modern: 57 **Bare-Hand Damage:** 1D10+7
HTH: 57 **AP:** 11

Significant Skills

	Rating
Administration	20
Computer Operation	33
Damage Control Procedures	42
Deflector Shield Operation	43
Deflector Shield Technology	32
Marksmanship, Modern Weapon	40
Negotiation/Diplomacy	24
Personal Combat, Unarmed	40
Shuttlecraft Pilot	10
Small Vessel Piloting	30
Space Sciences	
Astrogation	49
Astronomy	47
Astrophysics	44
Starship Helm Operation	20
Starship Sensors	20
Trade and Commerce	20
Trivia, History Of Spaceflight	12
Value Estimation	20
Warp Drive Technology	10

Distinguishing Physical Characteristics:

A young man with a trace of a Russian accent, Alexei Orlov is slight and wiry, with blond hair worn somewhat long.

Brief Personal History:

Alexei graduated from the merchant academy only four years ago, and entered the service of Spica Lines, a fairly large shipping company. The line recently went into receivership, however, and young Orlov found himself in need of a job; the *Two Brothers* needed a navigator, so he signed on.

Personality:

Motivations/Desires/Goals:

Right now Orlov's, main goal is job security. Having had a major company collapse out from under him, he is worried about the chance of success a small outfit like the *Two Brothers* can hope for. He is driven by a desire to make good, something his own father was never quite able to do; this feeds his concerns over the future and makes him even more prone to worried introspection.

Manner:

Orlov is a very serious, intense young man, with few outside interests. He prefers to spend his time either working, or studying technical manuals relating to his work. It is very rare for him to unbend and relax.

Special Knowledge/Powers:

None

Money:

8333 CR

Name: MBOYA, Jomo

Current Assignment: *Mission Class Commercial Transport
Two Brothers, Federation registry*

Position: Cargo Handler

Race: Human

Age: 32

Birthplace: Terra/United States Of Africa

Sex: Male

Attributes

STR —85 CHA —47
END —87 LUC —71
INT —60 PSI —52
DEX —72

To-Hit; Modern: 51 **Bare-Hand Damage:** 2D10+5
HTH: 61 **AP:** 11

Significant Skills

	Rating
Bribery	10
Carousing	25
Gaming, Games of chance	20
Marksmanship, Modern Weapon	31
Mechanical Engineering	22
Negotiation/Diplomacy	10
Personal Combat, Unarmed	50
Small Vessel Engineering	10
Small Vessel Piloting	10
Starship Weaponry Operation	41
Starship Weaponry Technology	40
Streetwise	35
Trade and Commerce	10
Value Estimation	25

Distinguishing Physical Characteristics:

Mboya is a large, massively built man.

Brief Personal History:

Jomo Mboya's past is rather obscure to his shipmates. The big cargo handler first went into space after getting in trouble with the law, and is still wanted in connection with an unsolved homicide case. He was not actually responsible, but cannot prove his innocence. He is something of a drifter who takes odd jobs aboard merchant vessels, stays for a few months or even a year or two, then moves on. The *Two Brothers* is just the most recent of many such jobs.

Personality:

Motivations/Desires/Goals:

As a result of his trouble with the law, he has never returned to Terra, and he is very uncomfortable staying in any one place very long. He is a proud man, unwilling to ask others for help or to share his secret.

Manner:

Mboya keeps other people at a distance with a rough manner and a short temper, but is, in fact, a fairly gentle person for someone of his size and disposition. He is capable of giving a great deal of loyalty to the right person or group, but, once his temper goes, he is a very dangerous man to be around.

Special Knowledge/Powers:

Mboya has been on Coridan before, and is familiar with the capital city and various aspects of the local situation.

Money:

6000 CR

CREW OF THE ROULASHAKBALLIH

The crew of the *Roulashakballih* is mixed, as is common in Orion vessels. Members of other races often drift out to Rigel to find a haven from their own problems or to chase a romantic vision of the glamorous Orion 'pirates.' There are

3 non-Orions aboard. In addition to the crew detailed below, others may be created as needed using the quick character creation statistics in the second edition rules and in **Trader Captains And Merchant Princes**.

Name: AKALZED, Alemir

Rank: Captain

Current Assignment: Modified *Argon Class*
Commercial Transport
Roulashakballih, Orion Worlds registry

Race: Orion

Age: 52

Birthplace: Rigel/Alstaffirh

Sex: Male

Attributes

STR —79	CHA —78
END —61	LUC —74
INT —81	PSI —60
DEX —70	

To-Hit; Modern: 50 **Bare-Hand Damage:** 2D10 + 3
HTH: 48 **AP:** 11

Significant Skills

	Rating
Administration	20
Bribery	69
Carousing	55
Communication Systems Operation	10
Computer Operation	13
Computer Technology	10
Damage Control Procedures	36
Deflector Shield Operation	20
Deflector Shield Technology	10
Forgery	29
Language, Galacta	33
Leadership	73
Marksmanship, Modern Weapon	51
Negotiation/Diplomacy	74
Personal Combat, Unarmed	37
Shuttlecraft Pilot	10
Small Unit Tactics	14
Small Vessel Piloting	51
Space Sciences	
Astrogation	49
Astronomy	26
Astrophysics	24
Starship Combat Strategy/Tactics	82
Starship Helm Operation	20
Starship Sensors	10
Streetwise	74
Trade and Commerce	70
Value Estimation	10
Vehicle Operation, Ground Craft	10
Warp Drive Technology	10

Distinguishing Physical Characteristics:

The Orion captain is stocky, but rather graceful in his movements. His features are ruddy but ruggedly handsome, and he is most readily noticed for his colorful and expensive clothing — an almost barbaric combination of gaudy, silk-like robes and fur trimmings.

Brief Personal History:

Akalzed's past is a checkered one. He has spent almost 30 years as a trader, a smuggler, and, at times, a pirate; these are interchangeable professions among most Orion spacefarers. He was heavily involved in dilithium smuggling on Coridan, but had nothing to do with the plot to start a Federation civil war (that isn't his style). He also has been known to trade in slaves, including the green-skinned Orion slave girls.

Personality:

Motivations/Desires/Goals:

Alemir Akalzed is a larger-than-life rogue, the Orion equivalent of a Cyrano Jones or a Harry Mudd. He's not really in it for the money, though he'll never turn away the chance to make an honest, or even a dishonest, buck. He treats life as a sort of game to be challenged and won each day. For all his larcenous Orion heart, Akalzed has high moral standards. He doesn't like to hurt people who can't defend themselves, or swindle those who can't afford it.

Manner:

The Orion captain is an engaging and colorful figure, a con man, a swindler, and a pirate (and proud of it). He is flashy, boisterous, and charming, and has the knack for dominating a room or a situation. Akalzed usually has some kind of get-rich-quick scheme going on, and is said to be able to charm a Klingon right out of his hobnailed boots.

Special Knowledge/Powers:

Akalzed is intimately acquainted with the wilderness areas of Coridan, and with all facets of past and present mining operations run there by Orion smugglers.

Name: SINDIKHABH, Omalla

Rank: First Officer

Current Assignment: Modified *Argon* Class
Commercial Transport
Roulashakballih, Orion Worlds registry

Position: Chief Officer

Race: Orion

Sex: Male

Attributes

STR —62 CHA —41
END —54 LUC —03
INT —62 PSI —40
DEX —58

To-Hit; Modern: 53
HTH: 9

Bare-Hand Damage: 1D10+3
AP: 9

Significant Skills	Rating
Administration	45
Language, Galacta	15
Marksmanship, Modern	40
Small Vessel Piloting	43

Name: GARON, Zarg

Rank: First Officer

Current Assignment: Modified *Argon* Class
Commercial Transport
Roulashakballih, Orion Worlds registry

Position: Chief Engineer

Race: Tellarite

Sex: Male

Attributes

STR —68 CHA —45
END —64 LUC —25
INT —67 PSI —37
DEX —48

To-Hit; HTH: 38

Bare-Hand Damage: 1D10+6
AP: 8

Significant Skills	Rating
Astronautics	42
Language, Galacta	10
Orion	25
Personal Combat, Unarmed	28
Small Vessel Engineering	60

Name: SURHAD, Mahendar

Rank: Second Officer

Current Assignment: Modified *Argon* Class
Commercial Transport
Roulashakballih, Orion Worlds registry

Position: Helmsman

Race: Orion

Sex: Male

Attributes

STR —50 CHA —44
END —50 LUC —68
INT —58 PSI —49
DEX —55

AP: 9

Significant Skills	Rating
Small Vessel Piloting	48
Starship Weaponry Operation	30

Name: LANKHAR, S'ras

Rank: Fourth Officer

Current Assignment: Modified *Argon* Class
Commercial Transport
Roulashakballih, Orion Worlds registry

Position: Weapons Officer

Race: Andorian

Sex: Male

Attributes

STR —71 CHA —66
END —61 LUC —21
INT —67 PSI —80
DEX —55

To-Hit; Modern: 50

AP: 9

Significant Skills	Rating
Astrogation	26
Marksmanship, Modern	45
Starship Weaponry Operation	36

Name: LANSING, Deborah
Rank: Second Officer
Current Assignment: Modified *Argon* Class
 Commercial Transport
Roulashakballih, Orion Worlds registry

Position: Navigator

Race: Human

Sex: Female

Attributes

STR —55	CHA —61
END —48	LUC —80
INT —73	PSI —52
DEX —62	

To-Hit; Modern: 43 **Bare-Hand Damage:** 1D10+5
HTH: 42 **AP:** 10

Significant Skills	Rating
Astrogation	28
Language, Orion	30
Marksmanship, Modern	25
Personal Combat, Unarmed	23
Small Vessel Piloting	32

Name: AKINA

Position: Slave

Race: Orion

Sex: Female, Green-skinned

Attributes

STR —53	CHA —99
END —55	LUC —68
INT —25	PSI —13
DEX —92	

To-Hit; Modern: 46 **Bare-Hand Damage:** 1D10+6
HTH: 65 **AP:** 13

Significant Skills	Rating
Artistic Expression, Dancing	83
Singing	55
Carousing	77
Courtesan	86
Language, Galacta	20
Orion	30
Personal Combat, Unarmed	39
Streetwise	63

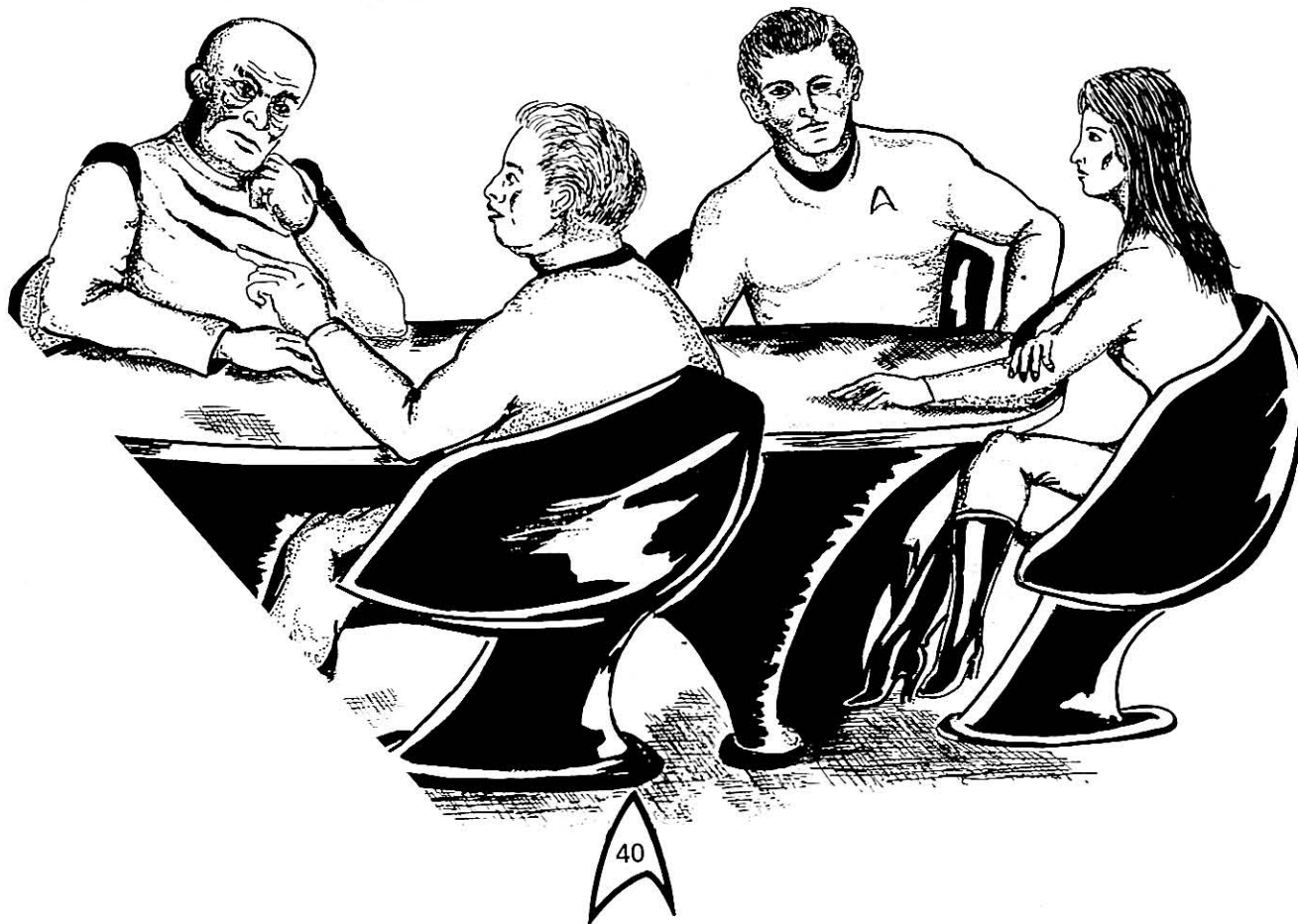

NON-PLAYER CHARACTERS

The characters described in this section are those individuals of importance encountered in the course of the adventure. Some are major figures, and are given a detailed description; others, much less important, have only a short description.

Name: JURGENS, Richard

Title: Vice President, TriMark Industries

Position: General Manager of Coridian Operations

Race: Human

Age: 40

Birthplace: Terra/United States Of Africa

Sex: Male

Attributes

STR —62	CHA —78
END —59	LUC —27
INT —80	PSI —01
DEX —54	

To-Hit; Modern: 27
HTH: 27

Bare-Hand Damage: 1D10+3
AP: 9

Significant Skills

	Rating
Administration	75
Bribery	34
Language, Caitian	10
Tellarite	30
Leadership	27
Medical Sciences	
Psychology, Human	48
Negotiation/Diplomacy	67
Social Sciences, Federation Law	54
Streetwise	22
Trade and Commerce	20
Value Estimation	36

Distinguishing Physical Characteristics:

Jurgens is tall, lean, and healthy in appearance, with close-set eyes and a smile that seems just a bit too ready to be honest.

Brief Personal History:

Jurgens has worked as an executive in several manufacturing and resource-exploitation firms over the years; he joined TriMark Industries 2 years ago.

Personality:

Motivations/Desires/Goals:

Many years ago, while on Tellar, Jurgens was involved in a rather shady scheme to bribe highly confidential information out of a Tellarite official. The scheme was successful, but a scandal resulted, in which Jurgens only barely managed to avoid being caught. He had thought that he had put that part of his life behind him, and now enjoys an excellent reputation for honesty and fair dealing, for which he was originally hired by TriMark, which sets high standards. Now, however, a Tellarite from Grupharg, who was involved in the original situation and who is one of the only people aware of the story, has threatened to expose Jurgens' role in the incident unless he supplies information to TriMark's rival. This he is doing, reluctantly, in an effort to keep his position and his reputation intact.

Manner:

Jurgens is reserved and studious, but capable of exerting a great deal of charm when engaged in salesmanship of any kind.

Special Knowledge/Powers:

Jurgens knows only what is described in the section on **The Investigation**.

Name: WINTER, Joseph

Rank: Lieutenant

Serial No.:

Current Assignment: Merchant Marine Command, Coridan
Protectorate
Planetary Observation Unit

Position: Post Commander

Race: Human

Age: 36

Birthplace: Terra/United States Of America

Sex: Male

Attributes

STR — 68 CHA — 81
END — 68 LUC — 16
INT — 50 PSI — 22
DEX — 65

To-Hit; Modern: 64 **Bare-Hand Damage:** 1D10 + 10
HTH: 66 **AP:** 10
Knife: 39

Significant Skills

	Rating
Administration	25
Computer Operation	24
Language, Caitian	10
Marksmanship, Modern Weapon	60
Negotiation/Diplomacy	9
Personal Combat, Knife	14
Unarmed	70
Security Procedures	40
Shuttlecraft Pilot	35
Small Unit Tactics	40
Zero G Operations	20

Distinguishing Physical Characteristics:

Winter is pale, dark-haired, with a perpetual sullen and petulant look that makes him look like a sulky child.

Brief Personal History:

Cadet Cruise, *USS Keppel*, Merchant Marine Command.
Failed.

Cadet Cruise, *USS Bolitho*, Military Operations Command. Failed.

Cadet Cruise, *USS Penn*, Colonial Operations Command.
Passed.

USS Livingston, Colonial Operations Command, 5 years.
Instructor (unarmed combat), Star Fleet Academy,
3 years.

USS Sparrowhawk, Merchant Marine Division, 2 years.

Winter, once known as 'Father Time,' was widely said to be the oldest passed-over Cadet in the service. He bids fair to do the same as a Lieutenant. Winter took 3 tries before passing a Cadet Cruise, and his career since then has been very unimpressive.

For the past year that Winter has commanded the Planetary Observation Unit on Coridan, he has done nothing to add luster to his service record. He replaced a somewhat more senior officer (with a larger staff) following the report that the Coridan Protectorate was running smoothly, and obtained the post largely through the machinations of his uncle, Admiral Robert Winter.

Personality:

Motivations/Desires/Goals:

Winter is basically beyond his capacity. This is not to say that he is completely useless; he is talented in hand-to-hand combat and in handling weapons of all kinds, and is quite accomplished in many other fields. But Winter is not officer material. He did well academically, but has no flair for leadership or decision-making; his continued survival in the service is due to influence (his uncle) and no small amount of boot-licking on his part. Winter's main goal in life is to keep others from noticing how far out of his element he really is. He accomplishes this through being pompous, self-important, and by making a lot of noise and activity substitute for actually getting his work done.

Manner:

Winter is usually "too busy to give time to that" or "studying the-situation for effective evaluation of the problem." He tends to be rude to non-entities such as the adventuring party, though someone important (even a scoundrel like Akalzed, who has only to make a noise about "giving offense to the Orion people" to make Winter get in line) can bring out his slavishly ingratiating side very quickly.

Special Knowledge/Powers:

Winter's power, such as it is, rests with his uniform. He commands the Midshipman and twelve enlisted ratings in the POU, and can recommend or not recommend actions to Star Fleet.

Name: MORROW, Karen

Rank: Midshipman

Current Assignment: Merchant Marine Command, Coridan
Protectorate

Planetary Observation Unit

Position: Deputy Unit Commander

Race: Human

Age: 23

Birthplace: Terra/United States Of America

Sex: Female

Attributes

STR —59	CHA —83
END —64	LUC —51
INT —85	PSI —14
DEX —70	

To-Hit; Modern: 51 **Bare-Hand Damage:** 1D10+7
HTH: 58 **AP:** 11

Significant Skills

	Rating
Administration	13
Communication Systems Operation	40
Communication Systems Technology	37
Computer Operation	41
Language, Orion	20
Spanish	20
Vulcan	20
Leadership	42
Marksmanship, Modern Weapon	32
Negotiation/Diplomacy	27
Personal Combat, Unarmed	45
Starship Sensors	19
Transporter Operation Procedures	18

Distinguishing Physical Characteristics:

Tall and red-headed, Karen Morrow is a very striking young woman.

Brief Personal History:

Morrow is still on her Cadet Cruise. She is already slated, however, for better things; she recently received orders to join the *USS Enterprise* as an Ensign in the ship's communications department, when her term on Coridan expires next month.

Personality:

Motivations/Desires/Goals:

Karen Morrow has the enthusiasm and optimism of youth; she is eager, ambitious, and tends toward overconfidence in her own abilities. She is fiercely determined to rise quickly, and ultimately aims for command.

Unfortunately, she is still somewhat immature. She thinks of everything in black and white terms, with every problem having a single right solution. She also can be guilty of wishful thinking in setting her goals and making plans for the future. By comparison with her superior, she is a real dynamo, and quite capable; she not-too-secretly despises him as a failure and a fool, but doesn't go so far as to be actually insubordinate.

Manner:

Morrow is full of energy, determination, and enthusiasm. She is quite capable, under the right conditions (the prospect of solving the hijacking where Winter has failed, for instance), of acting on her own initiative in a very direct and forthright way. This might mean that a group which has enlisted her support would find Morrow and some phaser-toting ratings acting as the cavalry coming to the rescue (if the gamemaster feels a need for this).

Special Knowledge/Powers:

Morrow's knowledge is covered elsewhere. She has the ability to intervene with an armed party once; since this is probably done against Winter's orders, an intervention at the wrong time will result in her being relieved of duty and unable to be of further assistance.

CREW OF THE GAVIKUGH

The 25 crewmen aboard the *Gavikugh* are all Tellarites employed by Grupharg. A few of them are given short character descriptions below, in case interaction with these individuals becomes necessary. Special notes indicate those crewmen who will specifically be encountered. The captain's description is given with other major NPCs, elsewhere.

Name: GRONKERN, Naroc

Rank: Captain

Current Assignment: *Kraphija* Class Medium Freighter *Gavikugh*, Tellar registry

Race: Tellarite

Age: 54

Birthplace: Tellar/Razan Province

Sex: Male

Attributes

STR — 73	CHA — 42
END — 72	LUC — 46
INT — 76	PSI — 01
DEX — 55	

To-Hit; Modern: 27 **Bare-Hand Damage:** 1D10+3
HTH: 27 **AP:** 9

Significant Skills	Rating
Administration	24
Computer Operation	19
Damage Control Procedures	45
Deflector Shield Operation	35
Language, Galacta	28
Leadership	45
Medical Sciences	
Psychology, Human	26
Tellarite	26
Negotiation/Diplomacy	10
Shuttlecraft Pilot	10
Small Vessel Piloting	10
Space Sciences	
Astrogation	44
Astronomy	20
Astrophysics	23
Starship Combat Strategy/Tactics	33
Starship Helm Operation	20
Starship Sensors	13
Streetwise	51
Trade and Commerce	20
Value Estimation	10

Distinguishing Physical Characteristics:

Gronkern is short, squat, and powerfully-built. His appearance is somewhat disfigured by an old burn scar on the side of his neck and face.

Brief Personal History:

A veteran merchant, Gronkern is a long-time Grupharg employee. He was employed for some time near the Rigellian frontier, and has a strong dislike for Orions in general (and Alemir Akalzed, an old rival, in particular). He was also involved in Tellarite smuggling operations on Coridan before the Protectorate.

Personality:

Motivations/Desires/Goals:

Gronkern is ambitious and greedy. He has little regard for law (and has been interpreting his instructions to put pressure on Coridan rather liberally; the company really had no desire to see innocent people killed. Perhaps his biggest ambition is to earn a clear-cut triumph of almost any kind over his Orion adversary, Akalzed, whom he hates passionately.

Manner:

Gronkern is blunt, argumentative, and easily moved to invective or violence.

Special Knowledge/Powers:

Gronkern may never be directly met or even seen; the description is included primarily to give insight into the nature of the group's chief opponent.

Name: KELLAK, Rojh
Rank: First Officer
Current Assignment: *Kraphija* Class Medium Freighter
Gavikugh, Tellar registry

Position: Pilot

Race: Tellarite **Sex:** Male

Attributes

STR —71	CHA —43
END —65	LUC —01
INT —62	PSI —21
DEX —64	

To-Hit; Modern: 51 **Bare-Hand Damage:** 1D10+5
HTH: 46 **AP:** 10

Significant Skills	Rating
Marksmanship, Modern Weapon	38
Personal Combat, Unarmed	28
Small Vessel Piloting	65

Kellak is the leader of the boarding party.

Name: GOR, Durag
Rank: Third Officer
Current Assignment: *Kraphija* Class Medium Freighter
Gavikugh, Tellar registry

Position: Purser's Mate

Race: Tellarite **Sex:** Male

Attributes

STR —67	CHA —44
END —65	LUC —15
INT —56	PSI —04
DEX —55	

To-Hit; HTH: 40 **Bare-Hand Damage:** 1D10+5
AP: 9

Significant Skills	Rating
Administration	33
Negotiation/Diplomacy	22
Personal Combat, Unarmed	25

Gor is the Tellarite contact who attempts to inform on his shipmates. He is the victim in the alley fight. He also was one of the Tellarites left behind during *Gavikugh's* absence.

Name: TOKHARV, Pharig
Rank: First Officer
Current Assignment: *Kraphija* Class Medium Freighter
Gavikugh, Tellar registry

Position: Chief Engineer

Race: Tellarite **Sex:** Male

Attributes

STR —67	CHA —43
END —71	LUC —01
INT —56	PSI —38
DEX —55	

To-Hit; Modern: 27 **Bare-Hand Damage:** 1D10+4
HTH: 37 **AP:** 9

Significant Skills	Rating
Astronautics	42
Personal Combat, Unarmed	19
Small Vessel Engineering	55
Warp Drive Technology	19

Name: KHER, Gruvar
Rank: First Officer
Current Assignment: *Kraphija* Class Medium Freighter
Gavikugh, Tellar registry

Position: Chief Officer

Race: Tellarite **Sex:** Male

Attributes

STR —67	CHA —38
END —56	LUC —56
INT —69	PSI —01
DEX —61	

To-Hit; Modern: 52 **Bare-Hand Damage:** 1D10+6
HTH: 45 **AP:** 10

Significant Skills	Rating
Administration	51
Bribery	36
Marksmanship, Modern Weapon	43
Personal Combat, Unarmed	30
Streetwise	67
Trade And Commerce	53

Kher was the character left behind in charge of the hijacking operations, using the cover of technical advisor to De-scale. Gor was his assistant.

Gamemaster's Notes

HINTS ON PLAY

CHARACTER DESCRIPTIONS

A number of character descriptions are provided in this adventure, suitable for use by players as individual player characters. Sufficient detail is included to permit these characters to be used immediately, saving on preparation time and allowing commencement of the actual adventure right away. It is quite possible that players will like these characters so well as to wish to retain them for use in further adventures or campaigns.

There is no reason, however, why these characters cannot be replaced by individuals from other merchant campaigns, or by newly created merchant characters. Other details may be altered as the gamemaster desires to make the adventure mesh with any group of characters, any ongoing campaign setting, or any Gamemaster's view of how the scenario will best serve the needs of a specific collection of players.

The adventure as described here centers around a *Mission Class* medium commercial transport, the *Two Brothers*. Player-characters (either pre-generated characters from this booklet or replacements for the indicated characters) should fill as many positions as possible on board, and particularly the role of the ship's Captain (who is the leader of the group). Any positions not filled by pre-generated or substitute player characters should be filled by the appropriate pre-generated characters as NPCs under the control of the gamemaster.

PILOTING THE TWO BROTHERS

Any time a character wishes to make a roll against skill at any position, however, a Saving Roll against the character's LUC score must be made, generally accompanied by coaxing, swearing, or banging at a key spot on the panel to get the ship to respond. As yet, the new owners haven't been able to get the money (500,000 credits) to set all these annoyances right, and this is one expense that TriMark is unlikely to cover unless an actual, major breakdown first occurs.

ALEMIR AKALZED

Akalzed is not currently engaged in smuggling operations. His visit to Coridan is perfectly legitimate (as legitimate as anything the Orion captain does, that is). He is intended as a red herring and as a possible ally. He also would make a useful recurring figure in an ongoing merchant campaign, whether as an opponent, a patron, a friend, or just to interject a note of levity. He is meant to be played in the same spirit as Cyrano Jones or Harry Mudd; Akalzed is competent and talented, but above all, colorful.

JUDGING THE INVESTIGATION

In the sections dealing with the investigation, each of the most likely places and people they may contact or examine is discussed. The information in each section has the following format. First, general notes about each encounter include basic impressions gained by the player characters, descriptive material, and the time spent conducting the basic inquiry. Second, information readily obtainable from that inquiry is detailed. Last, additional information that can be gained from the application of specific skills or other extra efforts is presented, together with the specifics on how that information actually is gained. This last section also contains any special encounters, problems, or assistance arising out of the contact.

The gamemaster is responsible for weaving these isolated pieces into a smooth and consistent whole. He may be forced to improvise in the face of unusual situations. For example, players might come up with someplace to look for information not covered in these pages, but perfectly reasonable, nonetheless. In such a case, the gamemaster must determine from his knowledge of the overall background just what information the players gain. Similarly, it may be that the adventurers come up with an unusual approach to dealing with a contact that is presented here; the nature of the approach may permit additional information to be gained. It is this regulation of unforeseen events and situations that makes the gamemaster crucial to any role-playing game.

When the application of a skill is indicated as providing additional news or information, the player must specify that he wishes to bring a specific skill into play to learn more from the subject being questioned. Then the player must make a Skill Roll against his character's rating in the indicated skill. A successful roll will permit the character to uncover the information. If the player doesn't think about the right skill or skills, the gamemaster might request him to make a Saving Roll against his character's LUC score, just to see if the character luckily stumbled on the proper skill anyway. The success of the Skill Rolls should be secret; players should never be sure if a subject has no more information, or just isn't admitting to it. (See the section **Secret Rolls and Hidden Success** in the second edition rules for some techniques to use.)

Other conditions by which adventurers may gain further information will be reasonably self-explanatory. The gamemaster is encouraged to come up with ways to flesh out these basic approaches, providing more detail and a greater chance of implementing specific encounters and events in and among the various inquiries.

SOLVING THE PUZZLE

The various investigations possible can lead the adventurers (and hence the players) to a correct solution of the mystery. It becomes reasonably clear that the Orions, everyone's favorite prime suspects, are really not involved, though the Tellarite crewman and the existence of the smuggling arrangements on board will at least confuse the issue.

In truth, of course, the Tellarites are responsible. They have been systematically arranging the hijackings (using Jurgens to supply information about Tarsine's arrangements to make the ambushes smoother), and then running the captured cargos through Descale Resources to be loaded on board their ship. The attack on their own shipment was largely a matter of camouflage.

The real plot runs deeper, however. Grupharg is angling to get a monopoly on the dilithium crystal trade from the Protectorate. Having correctly estimated the Federation's political situation and the quality of the POU team, the Tellarites have been applying pressure, which should cause the whole situation to come together to their liking. Descale Resources, of course, is very much aware of the whole scheme; they will benefit from the Tellarite monopoly by being in on the ground floor of the operation when the new system is implemented.

COMBAT WITH THE GAVIKUGH

For combat purposes, the ship has a Crew Efficiency Rating of 48%

ADVENTURE OUTCOMES

Obviously, the success or failure of the adventurers will have a profound impact on the outcome of this adventure. The gamemaster should impose the outcome that correlates most closely with the performance of the group, as outlined below.

Total Success

Ideally, the group will be completely successful in their efforts. The Tellarites will be discovered, their boarding action stopped, and the fleeing *Gavikugh* halted before it can escape from the system. However, there are still various permutations to the overall outcome even in the case of complete success, depending upon the exact course by which the adventurers reached this successful conclusion.

A constant aspect of success is continued employment by TriMark. Even if the group was fired by Jurgens, a successful resolution of the adventure will result in his being revealed (if he hasn't been already) as a part of the plot, and Calver, by subspace radio from Vega, will confirm the original arrangement. TriMark's Stock Profile Code will jump to 2B50, following a successful ending of the adventure, which makes the likelihood of a good profit even stronger.

Moreover, the adventurers can expect to see a bonus, probably paid by Tarsine Minerals and TriMark in combination. The exact nature of such a bonus is largely up to the gamemaster, but might include cash (10,000 to 100,000 credits would be a reasonable range), additional stock (and Tarsine stock should now climb to 3C44, thanks to the eclipse of Descale Resources), or possibly, new contacts or an offer of employment on some other TriMark operation elsewhere. Bonuses should not be of world-shaking proportions, but should be sufficient to justify the danger and difficulty the group has encountered.

If the adventurers involved Star Fleet in their successful resolution of the adventure, both Morrow and Winter (who is quick to grab what credit he can) will profit. Both might be useful contacts to be encountered in future adventures, Winter being transferred to some more interesting post in the Merchant Marine Command (possibly along the Rigellian frontier), while Morrow takes her post on the *USS Enterprise*, which could make for interesting encounters later on. It's always useful to have a friend on board a *Constitution* Class starship.

Failure to involve Star Fleet could cause problems. Winter is quite capable of taking revenge on any private citizens who show him up. This could be in the form of massive amounts of red tape, petty safety inspections and fines, or other bureaucratic harassment tactics. Winter then becomes an enemy, not a friend, if encountered in other adventures down the line. Morrow is too junior to be a dangerous enemy if Star Fleet is left out; indeed, she would probably enjoy her pompous superior's deflation so much that she would continue to be well-disposed (but probably not so actively friendly) to the adventurers in future encounters.

Should Alemir Akalzed become actively involved in the adventure, and particularly if his ship comes to the rescue in the final stages of the situation, one can be sure that he will have an angle. Picture him presenting a bill for services rendered to the group, and it wouldn't be a small one. On the other hand, Akalzed might like their style, and he just might be in a position to help them out even more. Perhaps he would merely tell them to look him up if they ever pass through Orion space, or perhaps he would tip them off to a lucrative trade arrangement out in the Rigellian worlds. Almost certainly he will be more than anxious to involve them in some scheme which is far from safe, far from legal, but

also far from unprofitable for everyone concerned. He'll probably also renew his sales pitch concerning Orion slave girls, but don't forget that a sale on Coridan is decidedly illegal.

The situation with regard to Jurgens is also flexible, but has little effect on the adventurers at present. If the group discovered and recruited Jurgens early on, he'll probably avoid a prison sentence. It's doubtful that TriMark will keep him on, but he could find another job and be a useful, reasonably friendly contact in future adventures. If Jurgens is not persuaded to cooperate, he faces prison, but could turn up a few months or years later as a very definite enemy out beyond the Federation frontier.

Less-Than-Total Success

Total success may elude the players; they may not choose to pursue the Tellarites aboard *Gavikugh*. If so, the Tellarite ship will probably escape; there are no Federation ships in easy range to prevent this.

The Grupharg corporation was not directly aware of the actions taking place on Coridan. The crew of *Gavikugh* has been instructed to 'put pressure' on Coridan as part of the company's bid to gain the dilithium export monopoly, but the corporate executives had not intended hijackings and ruthless murders; that was the Captain's idea. Once the scheme falls through, he knows that Grupharg will disown him. If he escapes, he will most likely flee beyond the frontier. He could turn up later, using his stolen ship for trade and even piracy on the fringes of civilization, and the gamemaster who so desired could arrange to have the Tellarites turn up in other adventures, thirsting for revenge against the merchants who ruined their perfect plot.

Failure

The consequences of failure are less pleasant to contemplate. For the most part, failure means that the hijacking will be successful and the adventurers killed. Even if they avoid this, it is certain that if the Tellarites are not exposed as the perpetrators of the crimes on Coridan, Grupharg ultimately will get its monopoly. Coridan will be closed to other outside companies. TriMark and Tarsine stocks will drop (to 4F70 and 4G56 respectively), while Grupharg and Descale will get correspondingly stronger (2B40 and 3C25). The TriMark charter will be terminated immediately. The stock will still be given to the group (it wasn't really their fault the charter failed, and they are still owed the agreed-upon fee), but the free expenses will be cut off and the value of the stock will plummet at an alarming rate. They won't have lost much, but neither will they be any further ahead than they were before.

CAMPAIGN STARTING POINT

Margin Of Profit is intended to be the starting point for a whole merchant campaign. The idea is to provide an initial situation that can make the adventurers some money, get them accustomed to certain aspects of merchant gaming (the stock market, various bits of background information, merchant character generation, and so on), and give them a solid adventure scenario to start off with. This, on the whole, is better than generating a group, handing them a ship and a star map, and saying "Okay, what do you want to do?"

Instead, players would start out with a fairly familiar adventuring situation, a concrete idea of their goals and objectives, and some excitement to hold their interest. Meanwhile the gamemaster can be preparing the real campaign (the map, etc.), and can find ways to lead the group into it. For role players more accustomed to the 'mission' type of adventure, which is most common to *STAR TREK*'s basic Star Fleet approach, this provides a certain degree of comfort, softening the transition from one type of adventure into another.

Coridan is really too close to the center of the Federation to make a good base of operations for long-term campaigning. It is strictly intended as a stopping point between character generation and the start of the kind of campaign discussed in **Trader Captains And Merchant Princes**. During the 6 months allocated to their charter (which can be glossed over after the end of this adventure), the players and their characters would get a chance to learn the ropes, make some money, and perhaps pick up some gamemaster-inspired leads about where they should really be.

The adventure contains a few items that could be used to generate elements of a campaign. Something set in the region around Rigel could be especially interesting. It's near the Klingon border, and, most importantly, it's the region the Orions call home. Alemir Akalzed and his crew furnish an excellent link between Coridan and a Rigellian-centered campaign, and the nearness of the frontier makes things interesting if there are any revenge-hungry Tellarites floating around looking for trouble.

Some of these possibilities may be explored in future adventures. Until then, though, the gamemaster is at the helm. What you choose to do is entirely up to the limits of your imagination and your image of what makes a good *STAR TREK* merchant campaign. This, and any other adventure or play aid, is but a first step; the rest is up to you.

ADAPTING TO ONGOING CAMPAIGNS

There are a number of alternative ways that **Margin Of Profit** may be played, giving it wider usefulness in a variety of game situations.

USING OTHER MERCHANT PLAYER CHARACTERS

The simplest variation possible is the substitution of alternate characters into the same basic situation. Characters could be the merchant characters drawn from an ongoing campaign, requiring various modifications in the adventure to suit the established background of the campaign. If this adventure were the start of a new campaign, they could be newly-created merchant characters of the players' own design, which would be used later as the campaign continued. In either case, the substitution is simple and straightforward.

USING A DIFFERENT STARSHIP

The player characters' ship type could be easily adapted from an ongoing campaign, because the adventure actually doesn't involve much shipboard action.

USING ORION PLAYER CHARACTERS

One potentially enjoyable alternative to the adventure as presented here would be to tell the story from the point of view of Alemir Akalzed's crew. The players could have a set of Orion characters in the position of being wrongly suspected of being the perpetrators of the hijackings and raids. With typical Orion disregard for due legal process, they could set out to discover the true criminals and deal with them personally.

What makes this an interesting possibility is the character of the Orion leader. As is noted elsewhere, Alemir Akalzed is another of the engaging con artists in the proud tradition of Harry Mudd. His methods would no doubt be quite unlike those adopted by conventional characters. And if he found the villains, would he be more likely to stop them (and so clear his name), or to find a way to cash in on their action? Such an adventure would certainly be a change of pace and could, again, lead to a whole campaign following the same crew of Orion ne'er-do-wells as their travels take them far and wide through Federation space.

USING STAR FLEET PLAYER CHARACTERS

The adventure need not be strictly limited to merchant characters at all. Given the weak Federation presence on Coridan, the sensitivity of the situation in the wake of the Babel Conference incidents, and the mysterious presence of these new, ruthless raiders, Star Fleet personnel could be sent in to investigate. This could take almost any form the gamemaster desires. A *Mission* Class courier with a handful of Star Fleet personnel might be dispatched to nose around quietly, or a starship (up to and including the *Enterprise* or one of her sister vessels) could be asked to look into the matter. Details of such an adventure would be up to the gamemaster to work out, depending on what type of Star Fleet group was involved and the resources they could command. However, the basic outline of events, situations, and important personalities could be drawn almost unchanged from this adventure booklet. The Coridan situation would make a nice change of pace from the usual Klingon or Romulan crisis.

Once again, this adventure could be interwoven into a whole campaign format. Think of the possibilities of periodic run-ins with Akalzed and his Orions, for instance, or evidence of other corrupt dealings by the Tellarite villains of Grupharg.

"I knew things were too good to be true!

"Our sweetheart stock deal with TriMark won't be worth lizard lips if we can't stop whoever has been hijacking the dilithium shipments. If the TriMark shipment next week is hit, our margin of profit will drop to nothing and we'll lose the *Two Brothers*. We'll have to take matters in our own hands if we want to keep our ship!

Hmmm...I wonder if that Orion 'trader' named Akalzed knows something about this..."

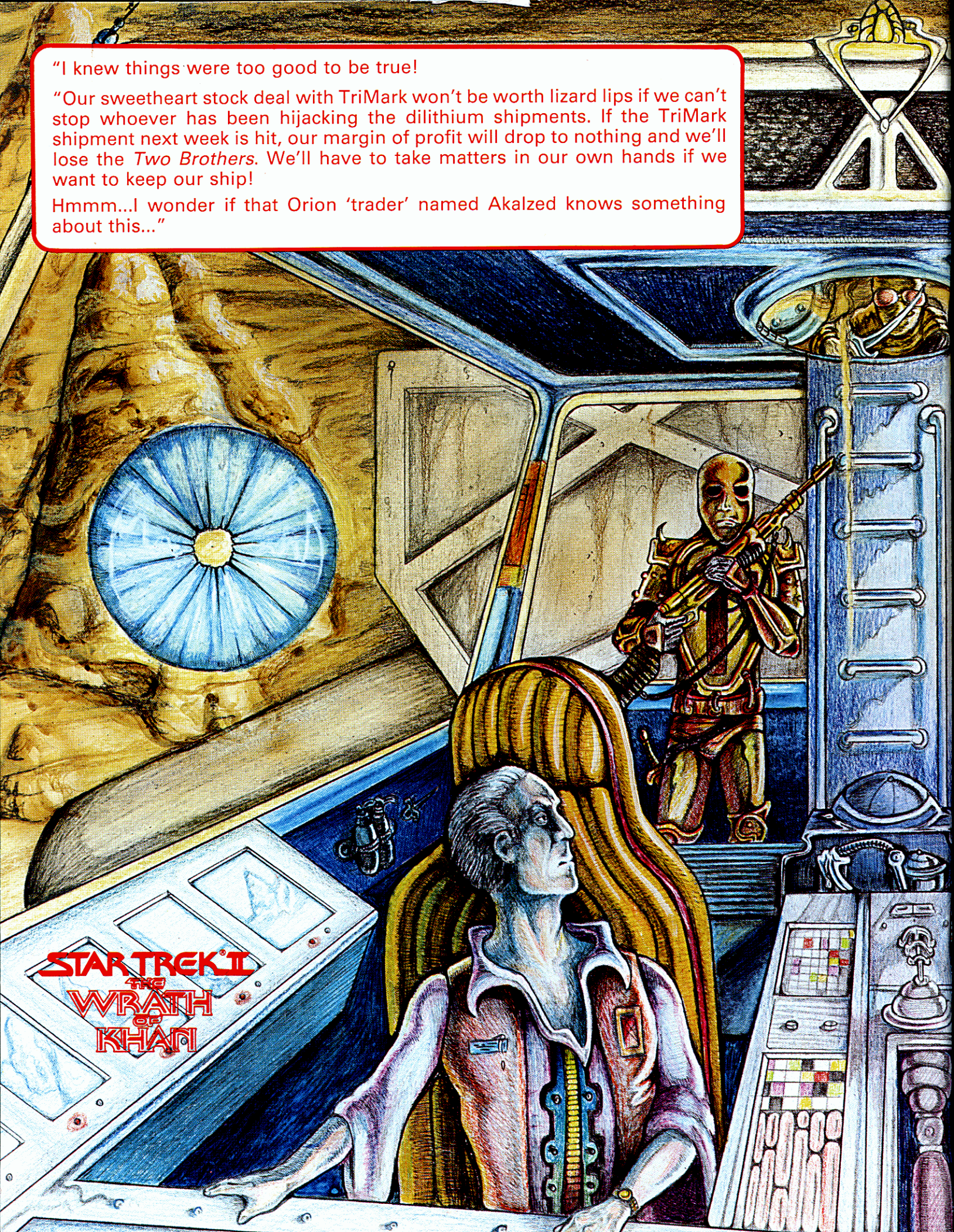

STAR TREK II
THE
WRATH
OF
KHANI